

BUN-YO-MATIC™

SURGICAL TECHNIQUE GUIDE

Bun-Yo-Matic™ Lapidus Clamp System

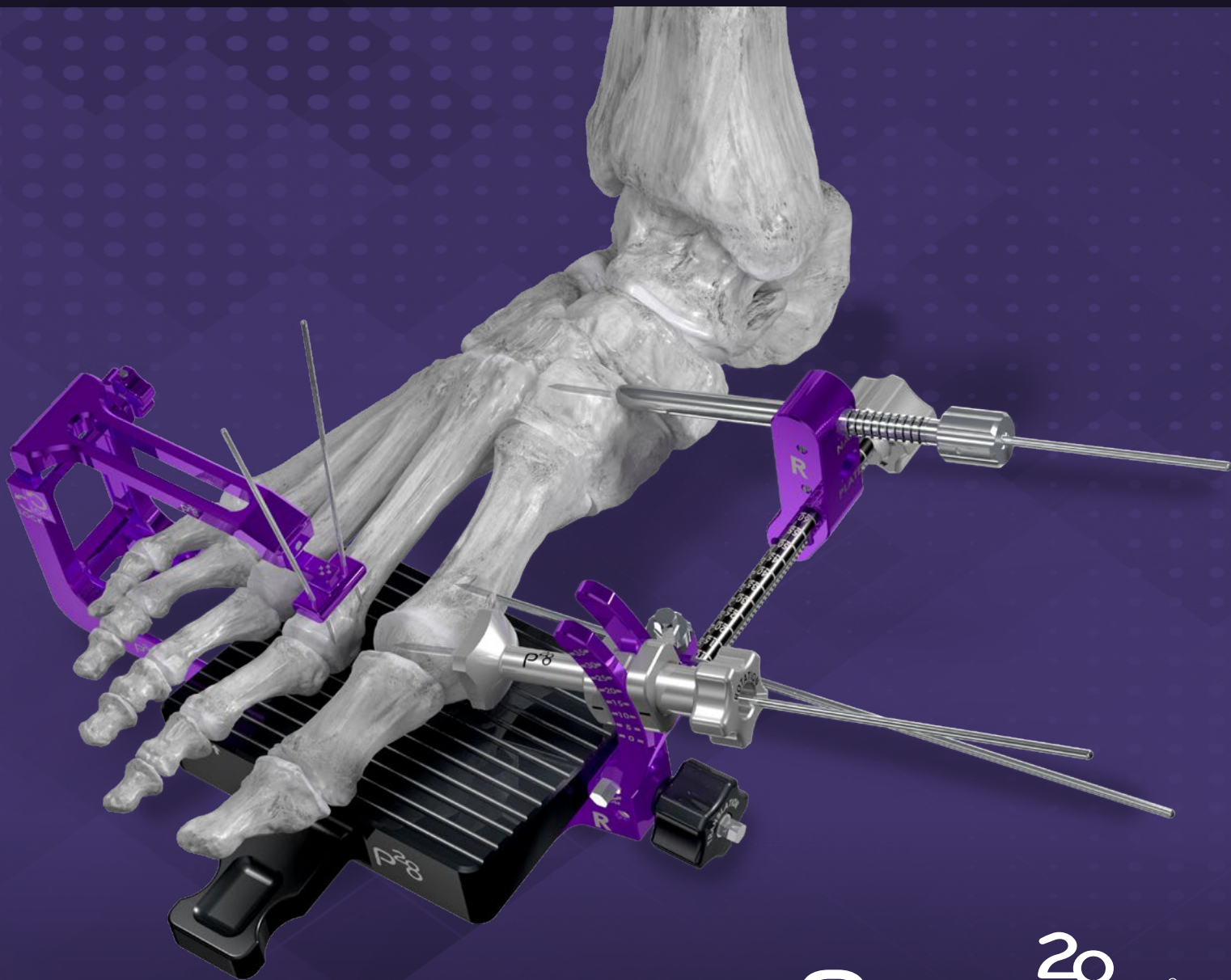

Paragon²⁰®

PRODUCT DESCRIPTION:

The Bun-Yo-Matic™ Lapidus Clamp System is used to assist with the de-rotation, IM angle reduction, and joint closure in a Lapidus arthrodesis. It is an instrument to aid in correcting bunion deformities in a more reproducible and controlled manner, while allowing for options in surgeon fixation compatible with the device (Paragon 28 Phantom® Intramedullary Nail or Paragon 28 Gorilla® Lapidus Plate).

The Bun-Yo-Matic Lapidus Clamp System is equipped with cutting guides designed to remove minimal bone from the base of the first metatarsal and the medial cuneiform to prepare the joint for fusion. The guides help establish parallel cut surfaces to improve apposition and arthrodesis following correction. The design then allows for guided corrections in all three planes while maintaining fluoroscopic visualization of the first metatarsal, sesamoids, and first TMT joint.

The Bun-Yo-Matic Lapidus Clamp System is designed to be the “first on and last off” system in a Lapidus arthrodesis case, holding correction until fixation is complete.

CONTENTS:

SECTION 1	FEATURED INSTRUMENTATION
	INSTRUMENTS..... 3
	BACK-TABLE ASSEMBLY 4
	PRE-CLEANING DISASSEMBLY 5
SECTION 2	SURGICAL TECHNIQUE
	INCISION AND CLAMP ATTACHMENT.....6-10
	METATARSAL CUT 11-13
	DEFORMITY CORRECTION13-14
	CUNEIFORM CUT.....15-16
	JOINT CLOSURE..... 17
	FINAL FIXATION18-21
SECTION 3	CADDY AND SAFETY INFORMATION , SMART BUN-YO-MATICSM INTEGRATION
	CADDY LAYOUT 21
	CADDY CONTENTS22
	SMART BUN-YO-MATIC™ INTEGRATION..... 23-24
	INDICATIONS, CONTRAINDICATIONS, WARNINGS 25-27

FEATURED INSTRUMENTATION:

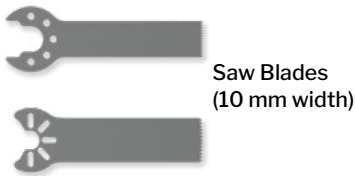
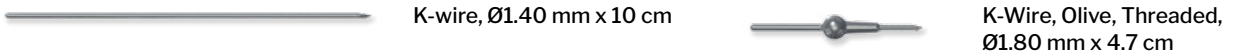

Bun-Yo-Matic™ Lapidus Clamp System Overview

CLAMP FEATURES:

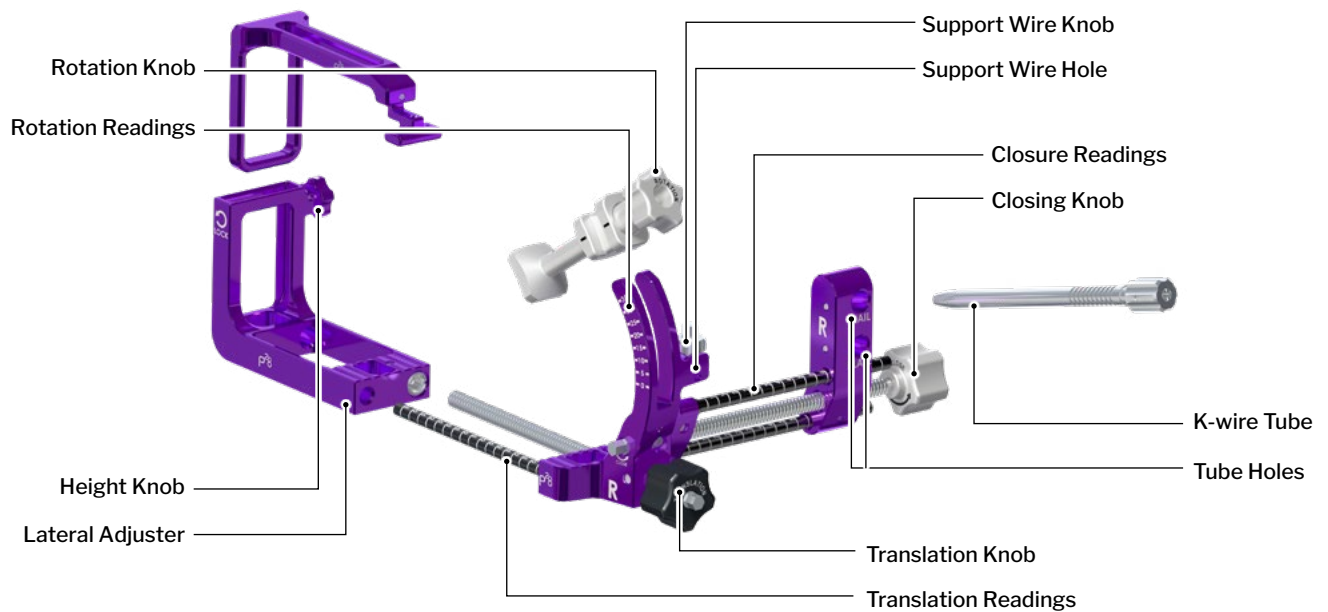

BACK-TABLE ASSEMBLY:



Insert the rods of the Rotator into the Lateral Adjuster. Rotate the Translation Knob clockwise until the Lateral Adjuster engages with the rods of the Rotator and continue rotating until the rods of the Rotator extend into the Lateral Adjuster approximately 5-10mm.

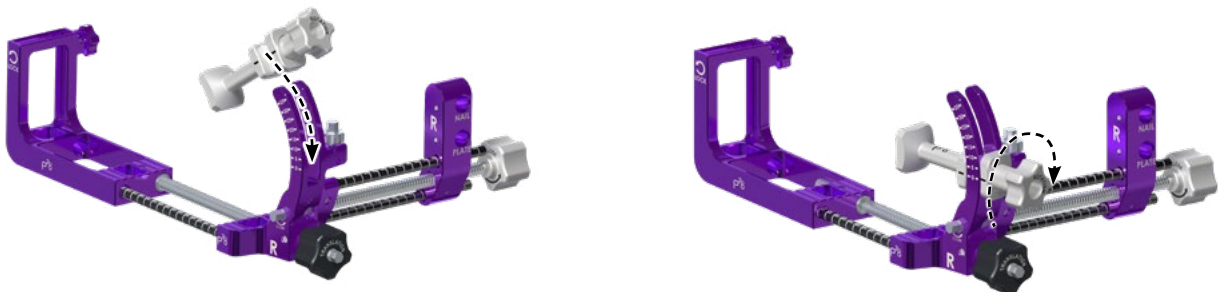

Insert the Metatarsal Paddle into the Rotator Arm. Slide the Metatarsal Paddle into the bottom-most (0°) position.

Turn the Rotation Knob clockwise until it is secure. **Do not over-tighten the Knob.**

The Clamp is now ready for use.

PRE-CLEANING DISASSEMBLY:



Rotate the Height Knob counterclockwise until the Lateral Hook is loosened from the rest of the clamp.

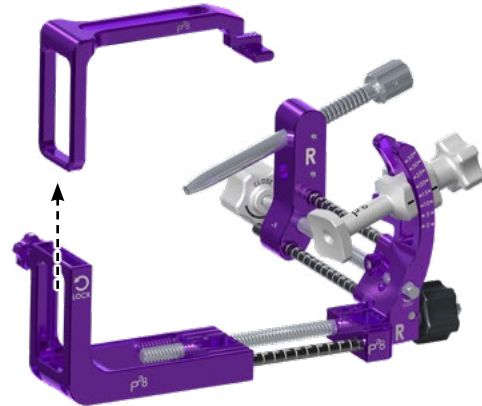

Pull up to remove the Lateral Hook from the rest of the clamp.

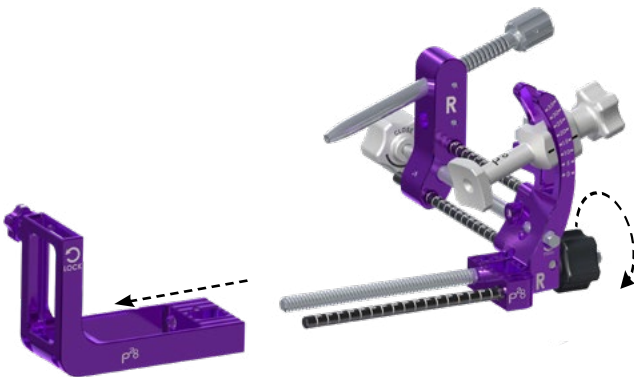

Rotate the Translation Knob counterclockwise until the Lateral Adjuster comes off the two rods.



Turn the Rotation Knob on the Metatarsal Paddle one full turn counterclockwise, or until loosened. Do not over-loosen the Knob.



Move the Metatarsal Paddle along the rotator arms of the Rotator until it is out of the Rotator.



Pull the proximal K-wire Tube out of the proximal end of the Rotator.



The Clamp is now fully disassembled.

Surgical Technique - Incision and Clamp Attachment



NOTE: If using Phantom® Intramedullary Nail fixation, place the provided sphere wire into the proximal plantar medial aspect of the medial cuneiform before beginning the following procedure.

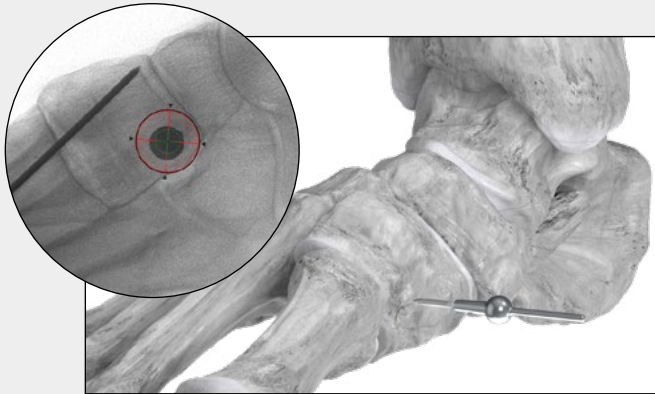

INCISION:

Make a dorsal-medial incision over the first tarsometatarsal (TMT) joint. Dissect the surrounding soft tissue to allow sufficient access to the joint. Proper soft tissue dissection at the joint space at this time is crucial to allow for sufficient correctional movement later in the technique.



NOTE: A lateral release at the first metatarsophalangeal (MTP) joint can be performed per surgeon's preference.

Make a dorsal stab incision over the distal second metatarsal shaft aligned with the first metatarsal head. Use a freer or similar instrument to mobilize the soft tissue for retraction along with the extensor tendon.



CLAMP ATTACHMENT:

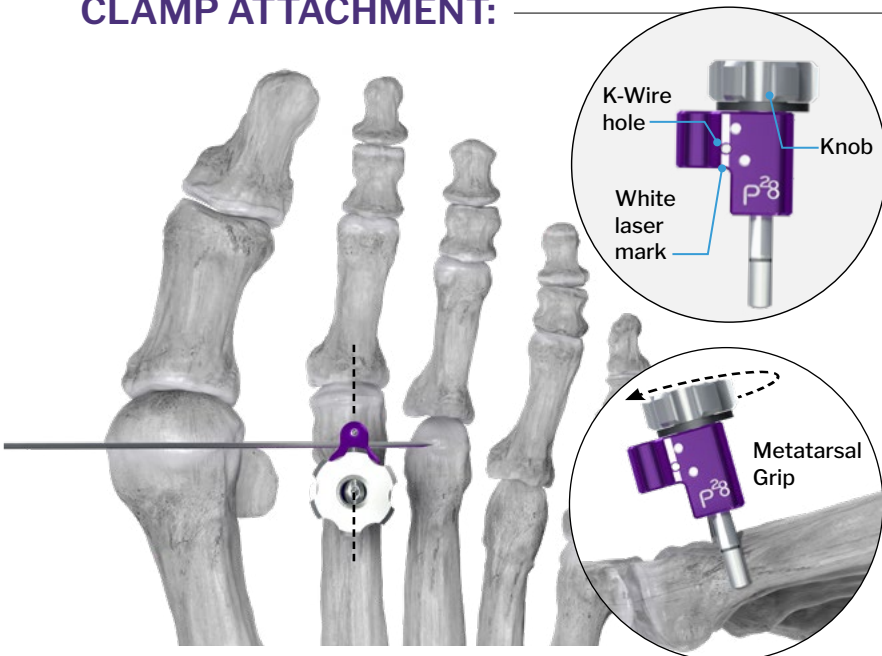

Attach the Metatarsal Grip to the second metatarsal neck such that the white laser mark on the side is in line with the bunion prominence. A K-wire can be inserted through the grip to help confirm this alignment. Ensure that the Grip is oriented perpendicular to the second metatarsal axis in the sagittal plane.

Tighten down the Metatarsal Grip by rotating the Grip knob clockwise until it grabs the metatarsal. Confirm position with fluoroscopy, ensuring that the distal wire hole is over the second metatarsal head and not over the MTP joint.

CLAMP ATTACHMENT:

Drive two Ø1.40 mm K-wires bicortically through the Metatarsal Grip wire holes, beginning with the proximal hole.

Turn the knob of the Metatarsal Grip counterclockwise to loosen, then pull the Grip up dorsally to remove from the anatomy while leaving the K-wires in place.

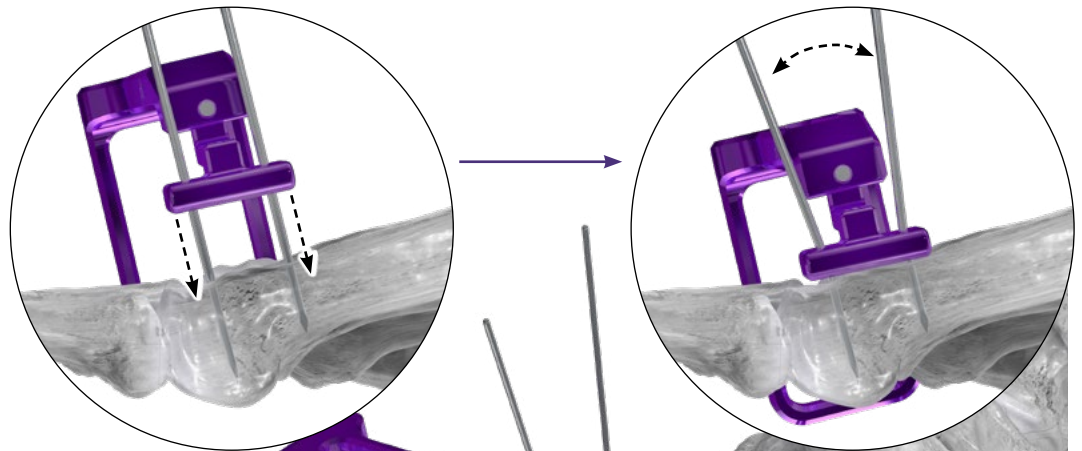
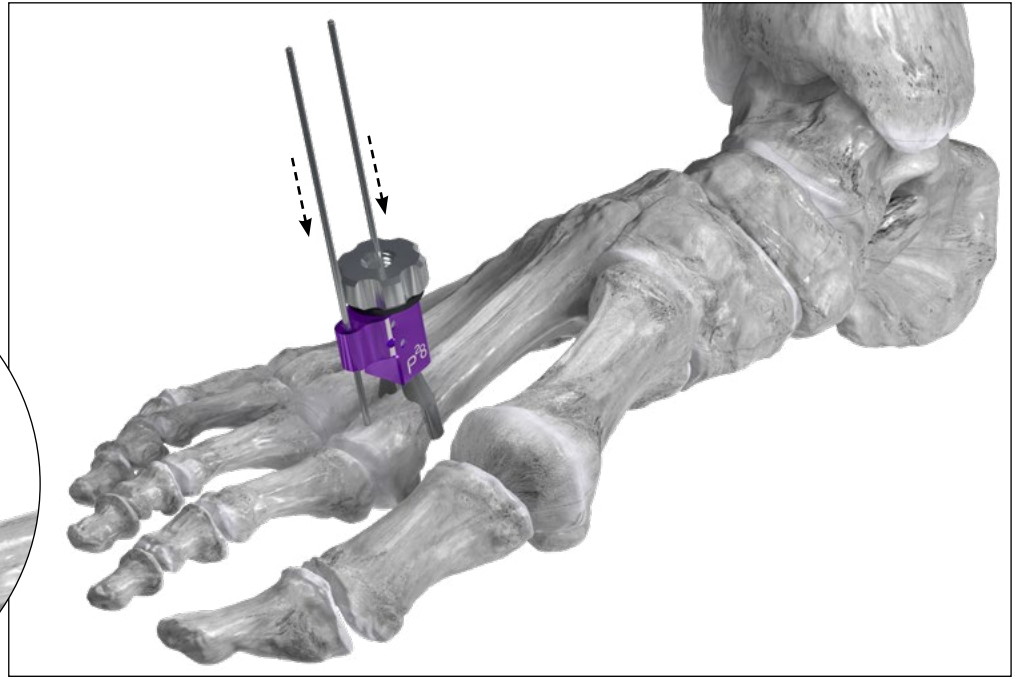
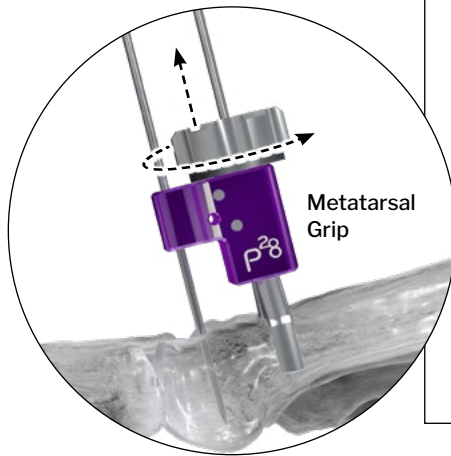

Slide the Paddle of the Lateral Hook over the two metatarsal wires and press down until the Paddle is fully seated on the dorsal surface of the skin. The wires will splay slightly to prevent liftoff.

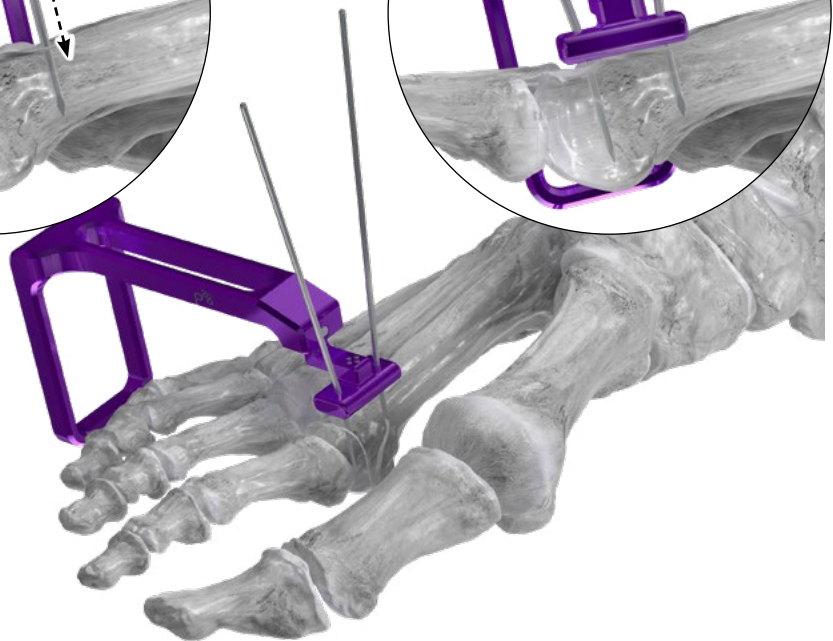

NOTE: The stab incision can be extended to allow the paddle to be seated on the bone and below the skin, if desired.

Surgical Technique - Incision and Clamp Attachment

CLAMP ATTACHMENT:

Slide the Lateral Adjuster on to the Lateral Hook, lightly tightening the purple Height Knob with clockwise turns until the attachment is secure.

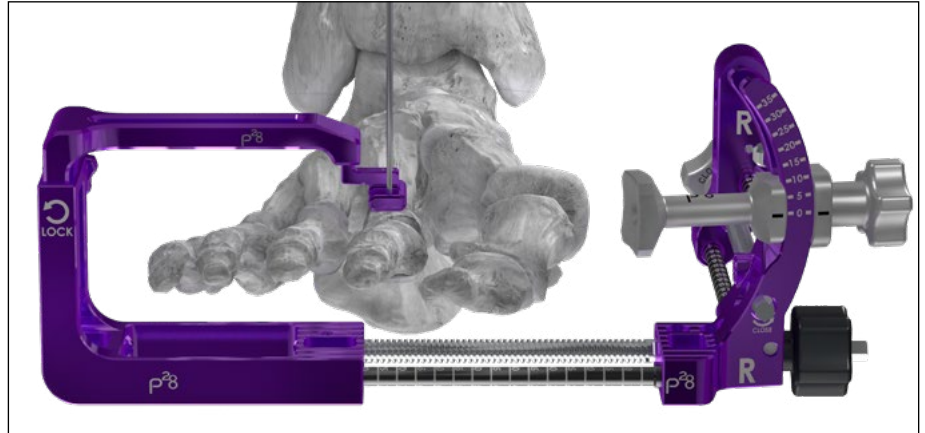
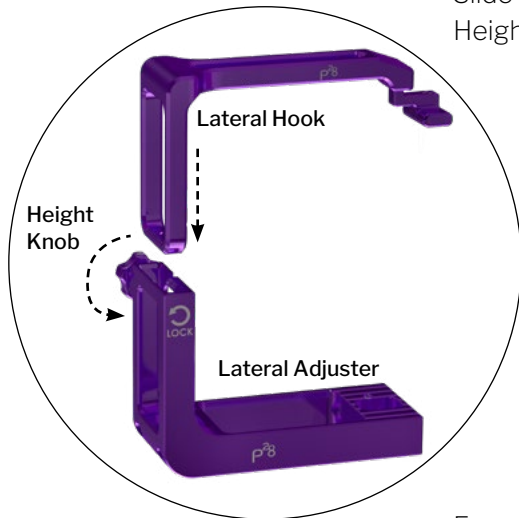

Ensure that the Metatarsal Paddle is in the most plantar (0°) rotational position. Turn the black Translation Knob clockwise to bring the Metatarsal Paddle in contact with the first metatarsal head. Do not perform IM angle correction at this time.

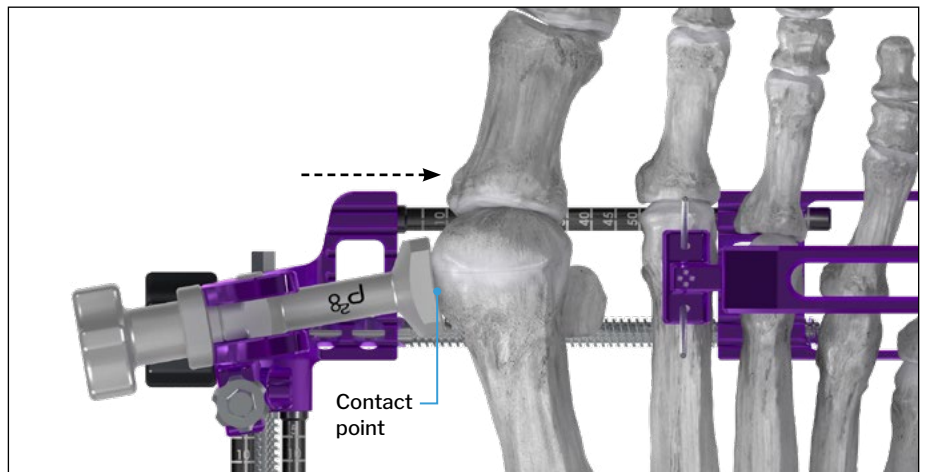
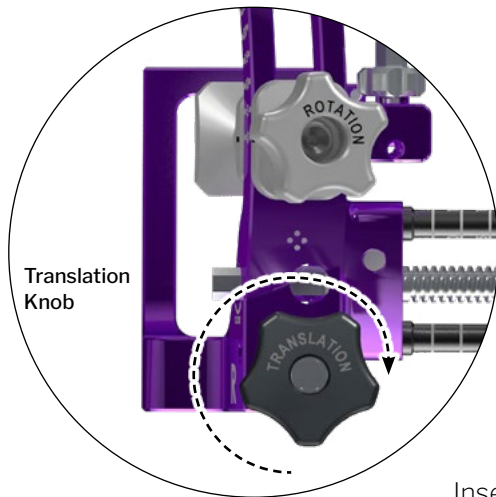

Insert the Wedge below the metatarsals until snug to simulate weight-bearing and to assist with clamp alignment to the foot. The Wedge should sit firmly on the medial and lateral brackets holding the threaded Translation rods.

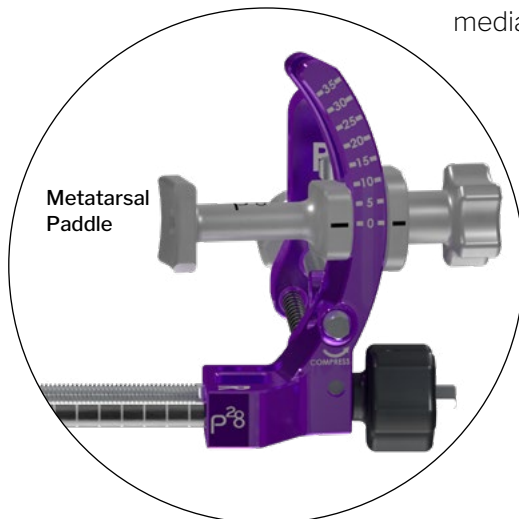

CLAMP ATTACHMENT:

Adjust and lock the device's plantar distance from the foot by loosening (counterclockwise turn) the purple Height Knob and sliding the Lateral Adjuster up or down the Lateral Hook until the Paddle is centered on the bunion prominence.

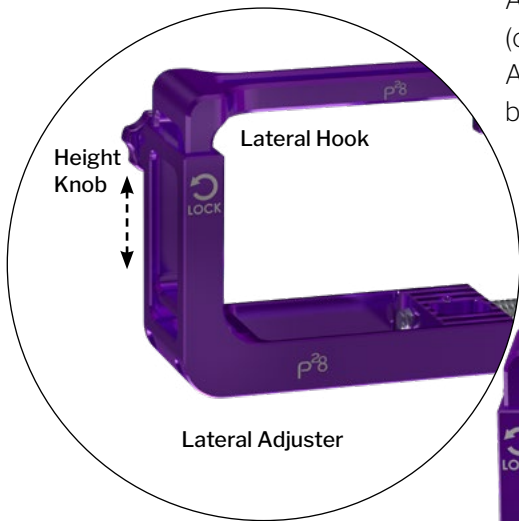

Secure this position by re-tightening (clockwise turn) the purple Height Knob. **Do not correct the IM angle at this time.**

When proper positioning is achieved, insert a Ø2.30 mm K-wire through the Metatarsal Paddle into the first metatarsal head percutaneously and bicortically to fix position.

NOTE: Gauze can be placed between the Metatarsal Paddle and the bunion prominence to help prevent skin irritation, if desired.

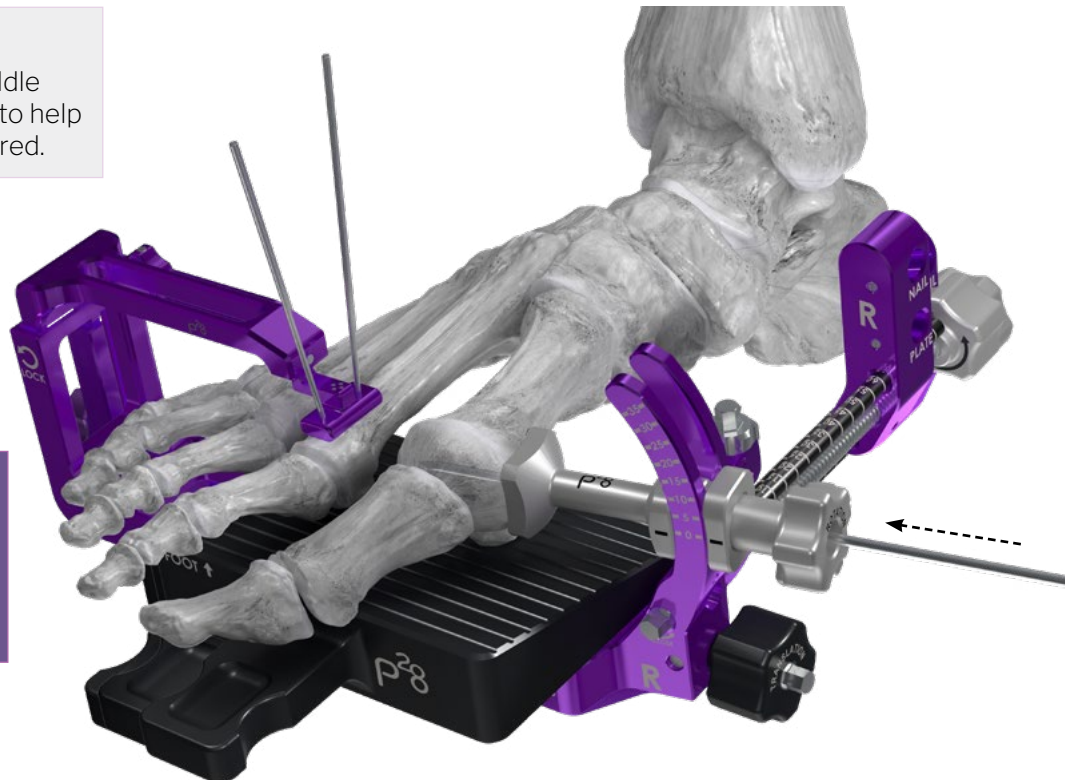

CRITICAL NOTE: The wedge must stay in throughout the procedure until joint-spanning fixation is performed.

Surgical Technique - Incision and Clamp Attachment

CLAMP ATTACHMENT:

Insert the K-wire Tube into the corresponding “Nail” or “Plate” hole at the proximal end of the clamp depending on which fixation option is to be used (e.g. Paragon 28 Phantom® Intramedullary Nail or Paragon 28 Gorilla® Lapidus Plate). Ensure the collet of the K-Wire Tube is loose. To loosen, grip the tube and turn the knob clockwise.

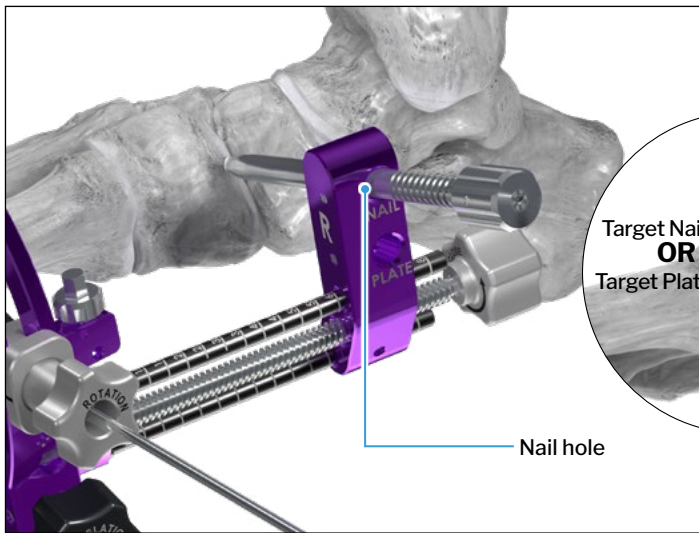
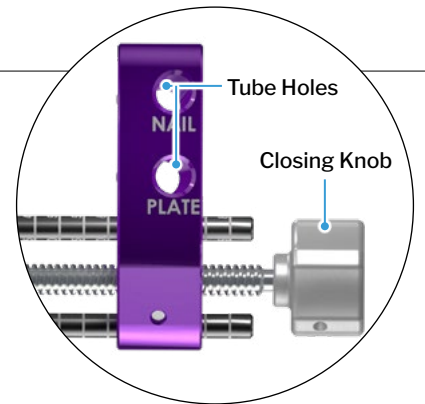

Nail configuration

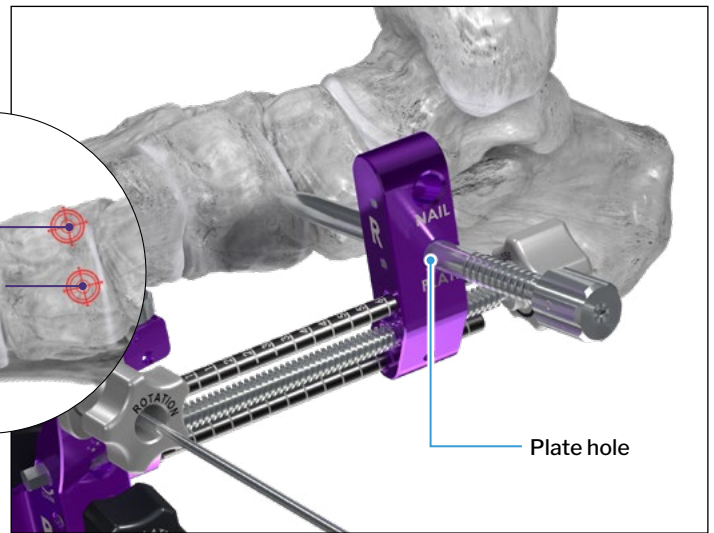
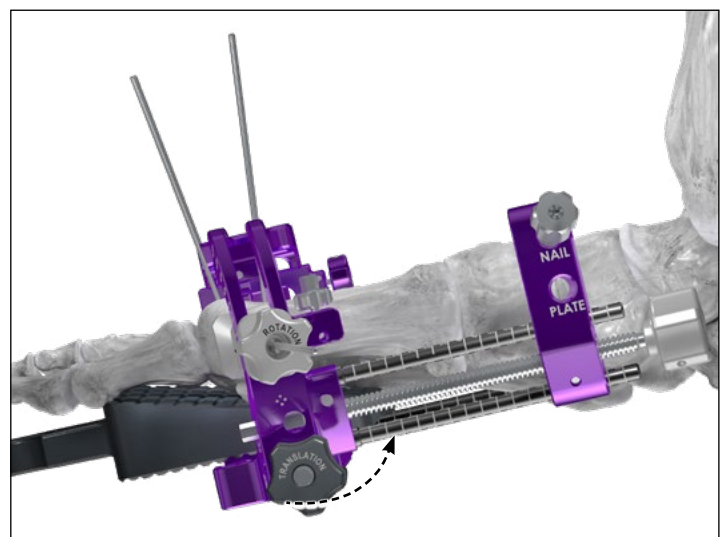
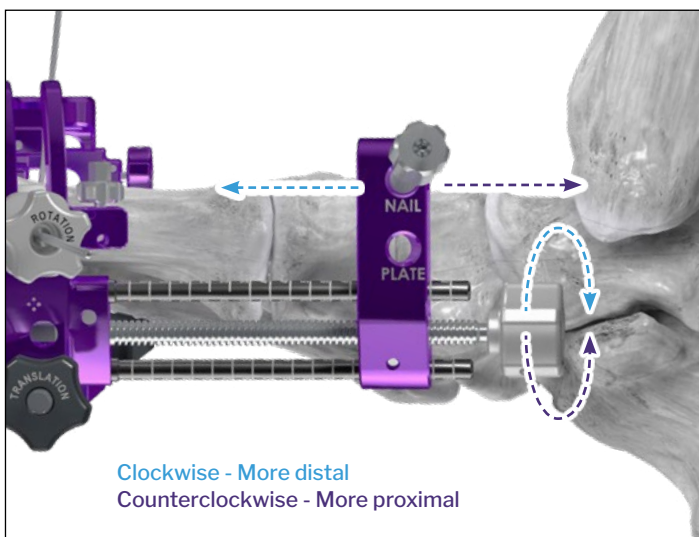

Plate configuration

Use a combination of the Closing Knob and pivoting the clamp in the sagittal plane to set the appropriate trajectory for the proximal K-wire through the K-wire Tube. The Tube should contact the proximal end of the cuneiform.



Once the proper position is achieved, drive a Ø2.30mm K-wire through the K-wire tube and into the medial cuneiform. Tighten the collet of the K-wire Tube with a clockwise rotation to secure.

METATARSAL CUT:

Insert the Metatarsal Cut Guide into the exposed first TMT joint, situating the Paddle flush against the metatarsal surface and pivoting in the coronal plane until the guide is in its most stable, dorsal-medial position.

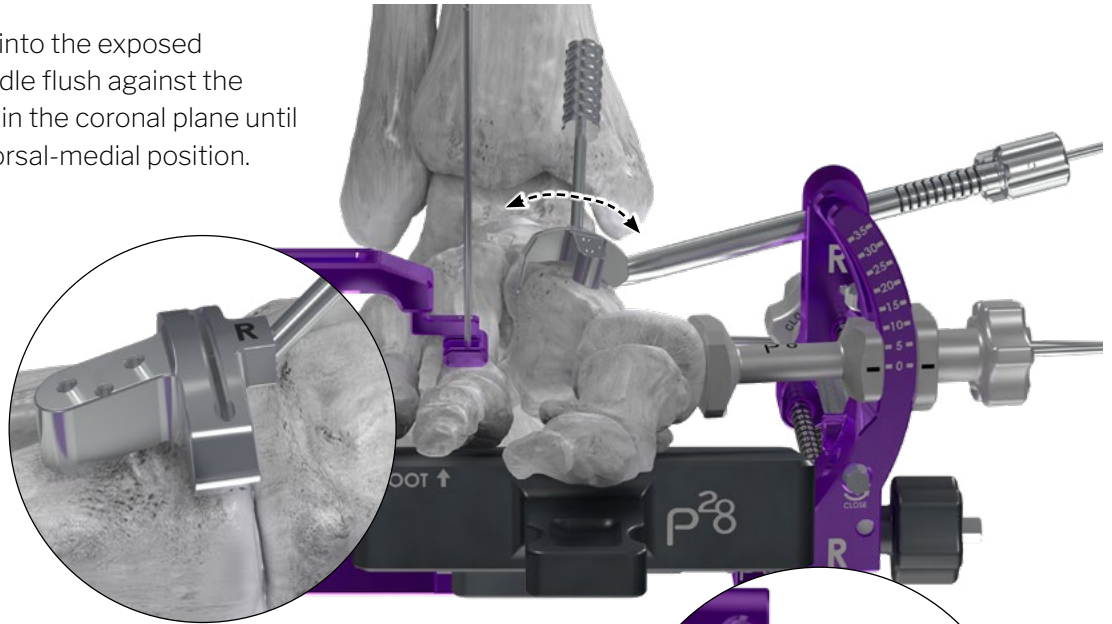
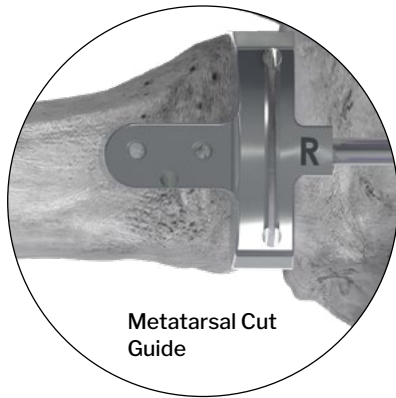

If Cut Guide insertion is difficult, distract the joint by turning counterclockwise on the Closing Knob.

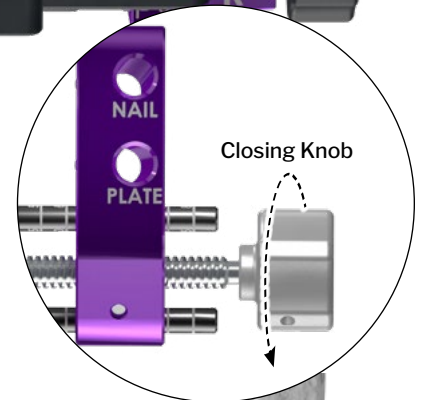

Insert two parallel and one oblique $\text{\O}1.40$ mm K-wires through the guide and into the metatarsal to secure.

Do not perform deformity correction until this cut is complete.

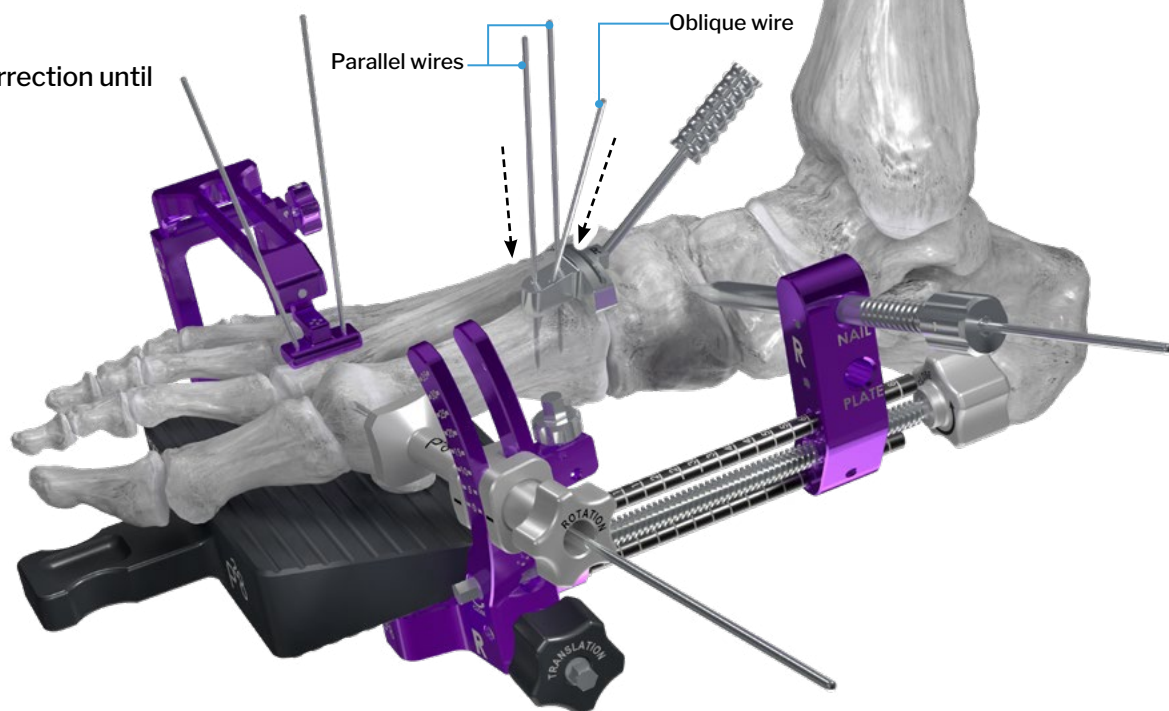

METATARSAL CUT:

OPTIONAL: ANTI-PENETRATION TOOL

This tool can be used to protect the second metatarsal from the saw blade during the metatarsal cutting step below. To use, wedge the Anti-Penetration tool between the first and second metatarsal at the base of the first metatarsal, then secure to the second metatarsal by driving a $\text{\O}1.40$ mm K-wire through one of the holes, being careful to avoid the neurovascular bundle.

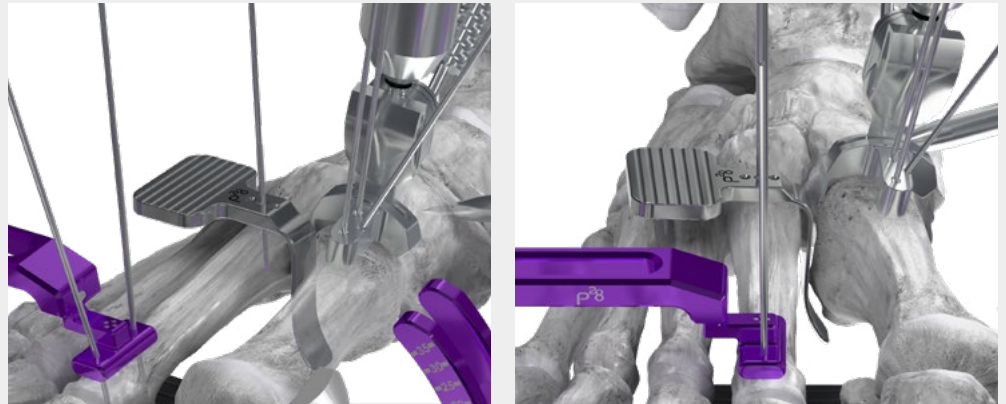

Use the provided saw blade to perform the metatarsal cut through the slot in the Cut Guide, using a sweeping method to ensure appropriate cutting of the metatarsal dorsally, laterally, and plantarly. Then **remove the oblique $\text{\O}1.40$ mm K-wire only** and pull the Cut Guide out of the joint. Remove the Anti-Penetration Tool from the anatomy, if used.

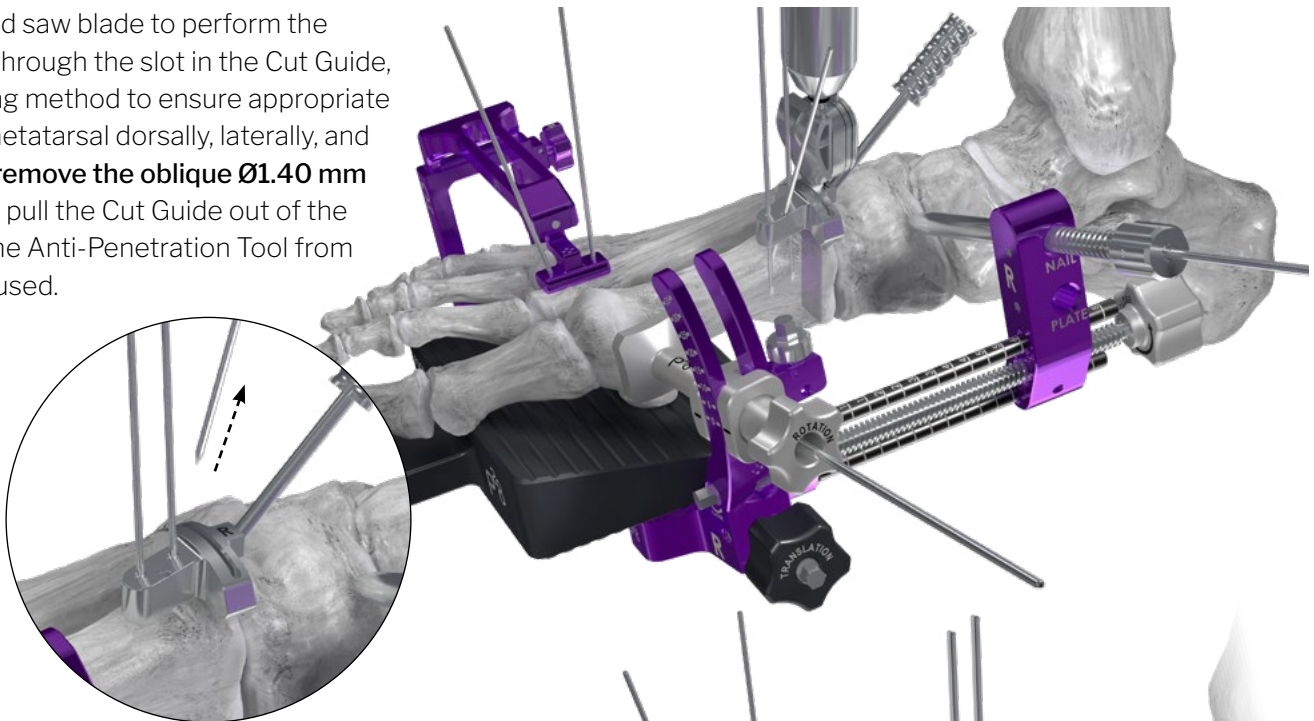

Leave the two parallel $\text{\O}1.40$ mm K-wires in place.

Remove the cut portion of the first metatarsal subchondral bone and cartilage from the joint using a preferred technique. Confirm that all residual bone fragments and cartilage are removed from the joint, and that the surface of the metatarsal base is flat and without fragments on the edges.

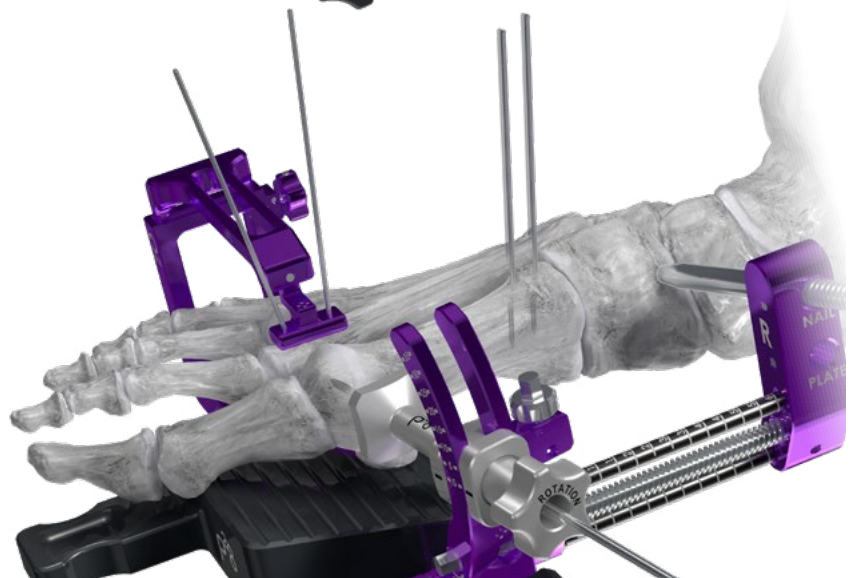

METATARSAL CUT:

The Closing Knob can be turned counterclockwise to distract the joint and improve visibility and access. Confirm cut success by visualizing with dorsal-plantar fluoroscopy.

IMPORTANT: Proper cleanup of this joint space is required for successful correction. Ensure that there are no lingering pieces of bone and/or cartilage in the space before moving on to the next step.

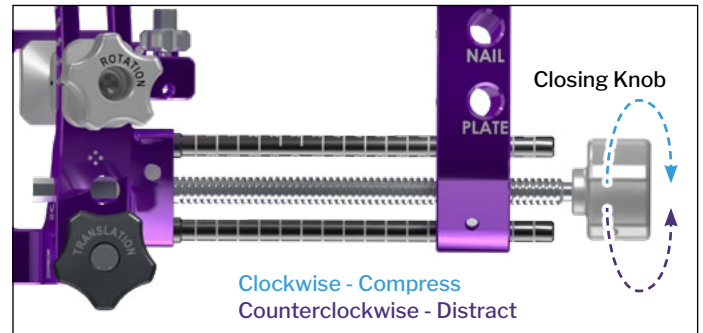

METATARSAL CORRECTION:

Once the metatarsal cut is completed and the joint space prepared, the clamp can be used to perform the following corrections in this order:

IM CLOSURE

- ▶ Rotate the Rotation Knob one half-turn counterclockwise to loosen.
 - Allows natural de-rotation during IM correction
- ▶ Turn Translation Knob clockwise to close IM angle

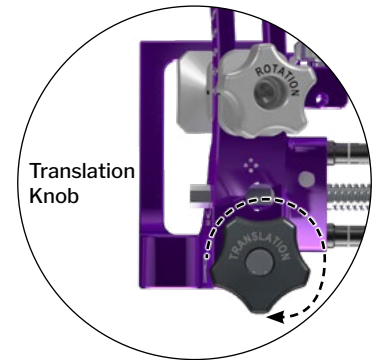
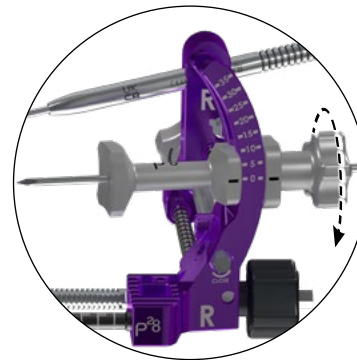

TIP: When the clamp is in a true AP orientation, the markers in the 2nd metatarsal paddle will appear as a clean “clover” pattern.”

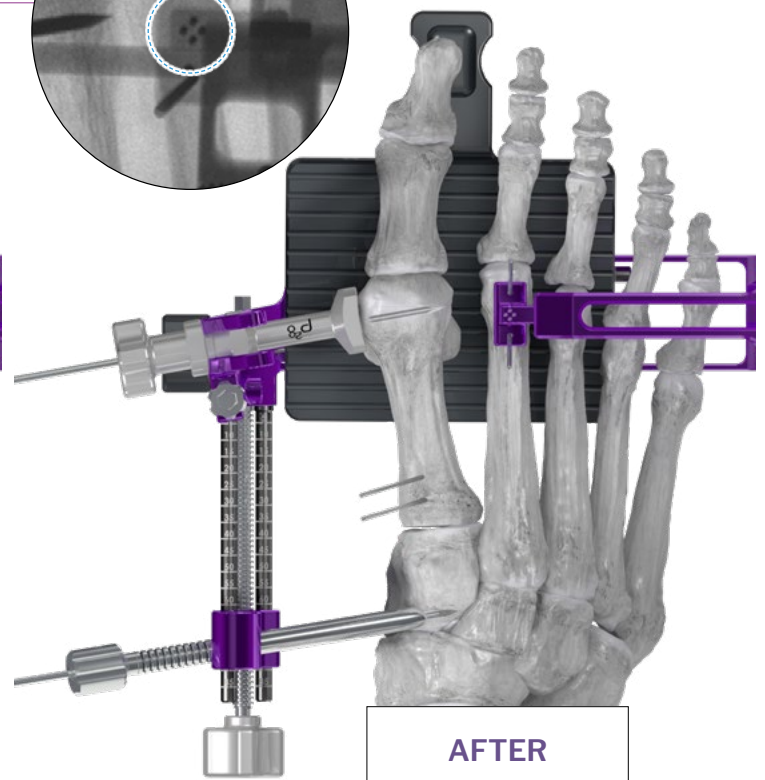
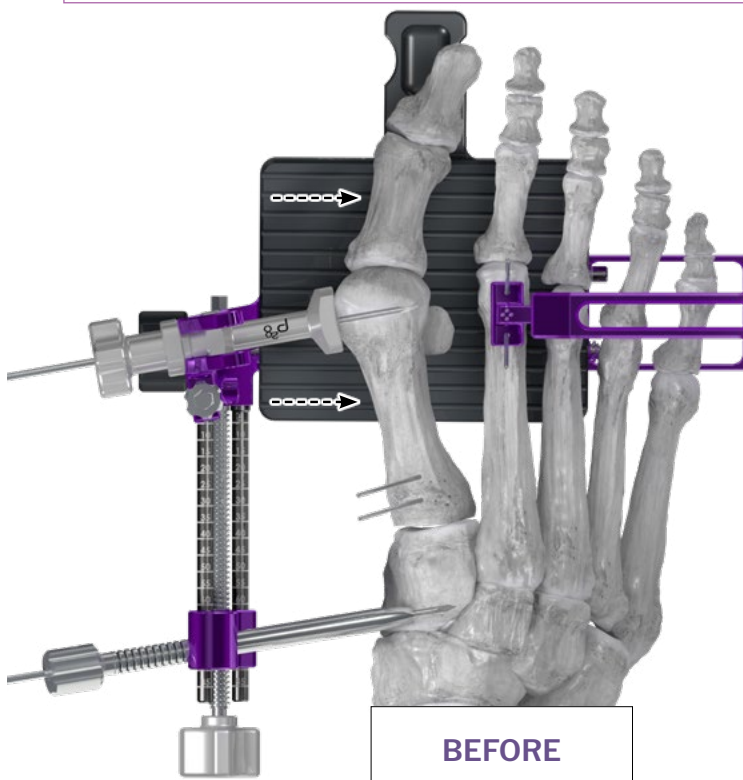
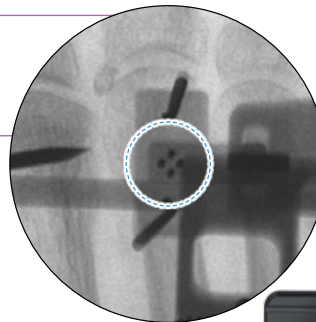

METATARSAL CORRECTION:

DE-ROTATION

- ▶ Rotate the Rotation Knob one half-turn counterclockwise to loosen, if not done previously.
- ▶ Slide the Metatarsal paddle dorsally up the Rotator Arms to perform de-rotation correction.
- ▶ Rotate the Rotation Knob one half-turn clockwise to lock and secure the correction.

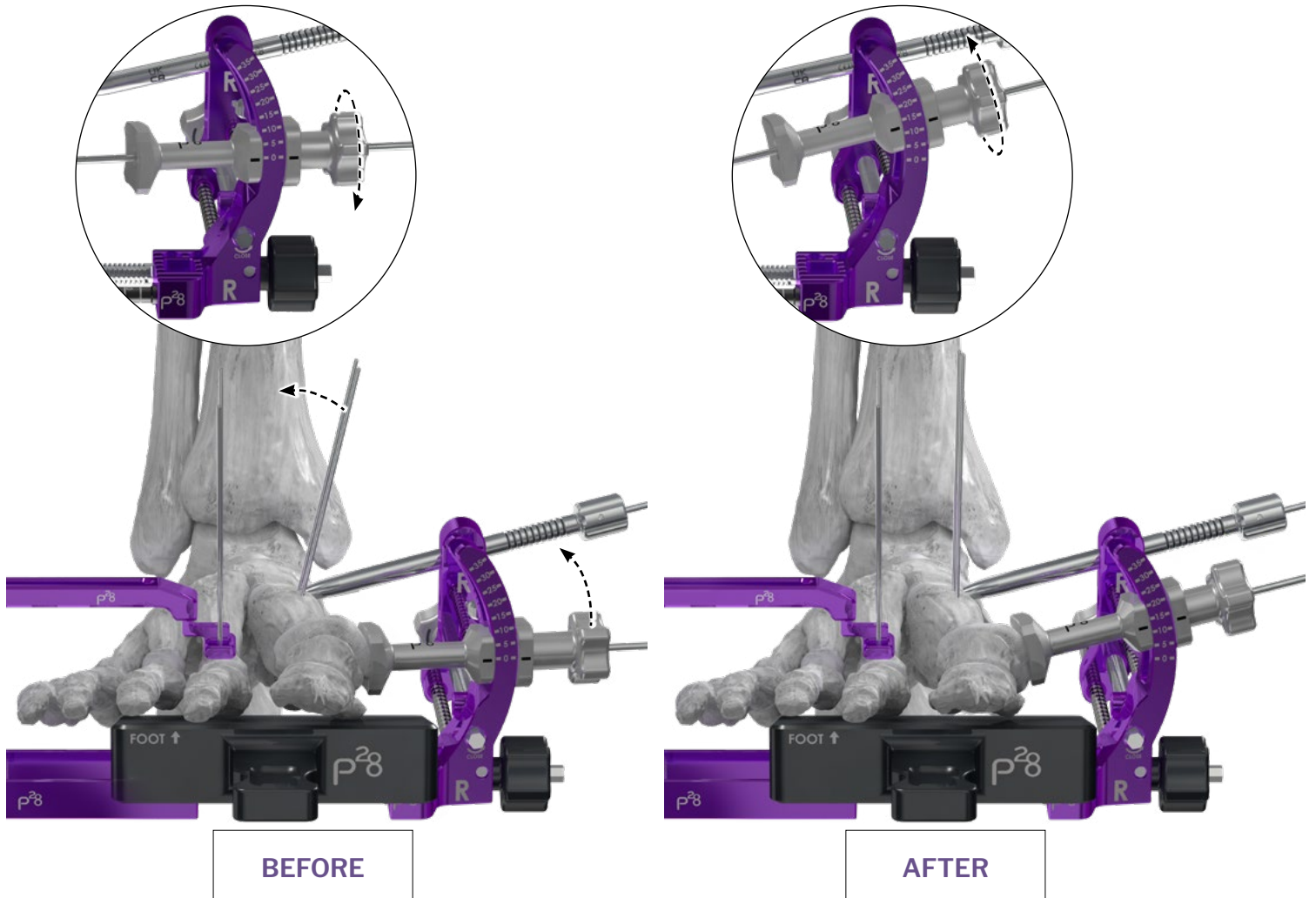

Complete any additional IM correction or metatarsal rotation as needed. Confirm the correction with fluoroscopy.



TIP: When the clamp is in a true lateral position, the markers near the Translation Knob will appear as a clean “clover” pattern.

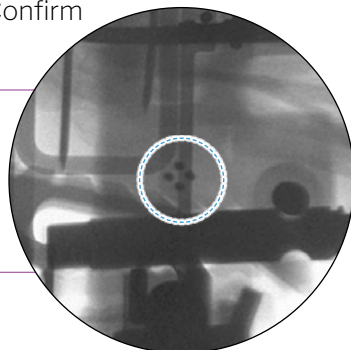

NOTE: If the base of the metatarsal appears to be shifting medially after rotation, it is recommended to resect the lateral aspect of the metatarsal base.

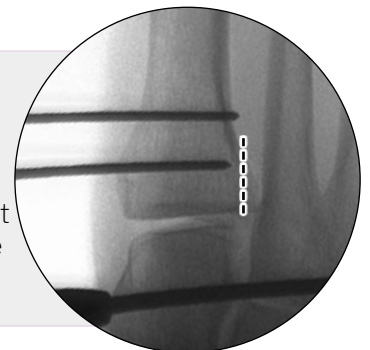

CUNEIFORM CUT:

Following deformity correction, perform the Windlass mechanism. While holding such positioning, insert a $\varnothing 2.30$ mm K-wire through the Support Wire Hole proximal to the Metatarsal Paddle and into the metatarsal shaft for additional stability of the first metatarsal. Check wire positioning under fluoroscopy and adjust as needed, **ensuring that the wire is not in the 2nd metatarsal.**

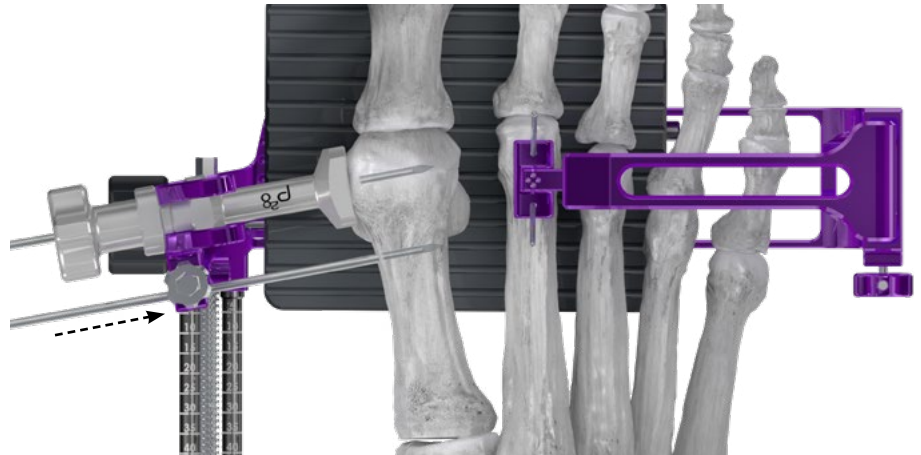

Lock this wire with the Set Screw just above the hole by rotating clockwise.

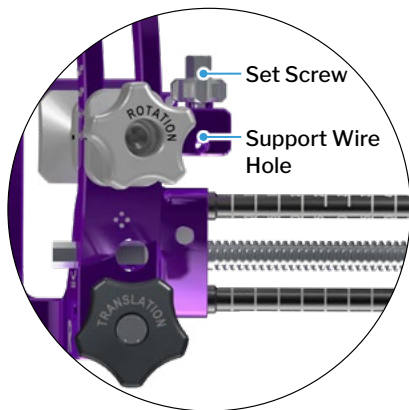

IMPORTANT: Proper placement of this support wire is crucial for effective joint closure after the cuneiform cut is made. Ensure that the wire has not exited the lateral cortex of the 1st metatarsal to avoid reduction misalignment.

Slide the Cuneiform Cut Guide over the two parallel $\varnothing 1.40$ mm K-wires and into the first TMT joint space.

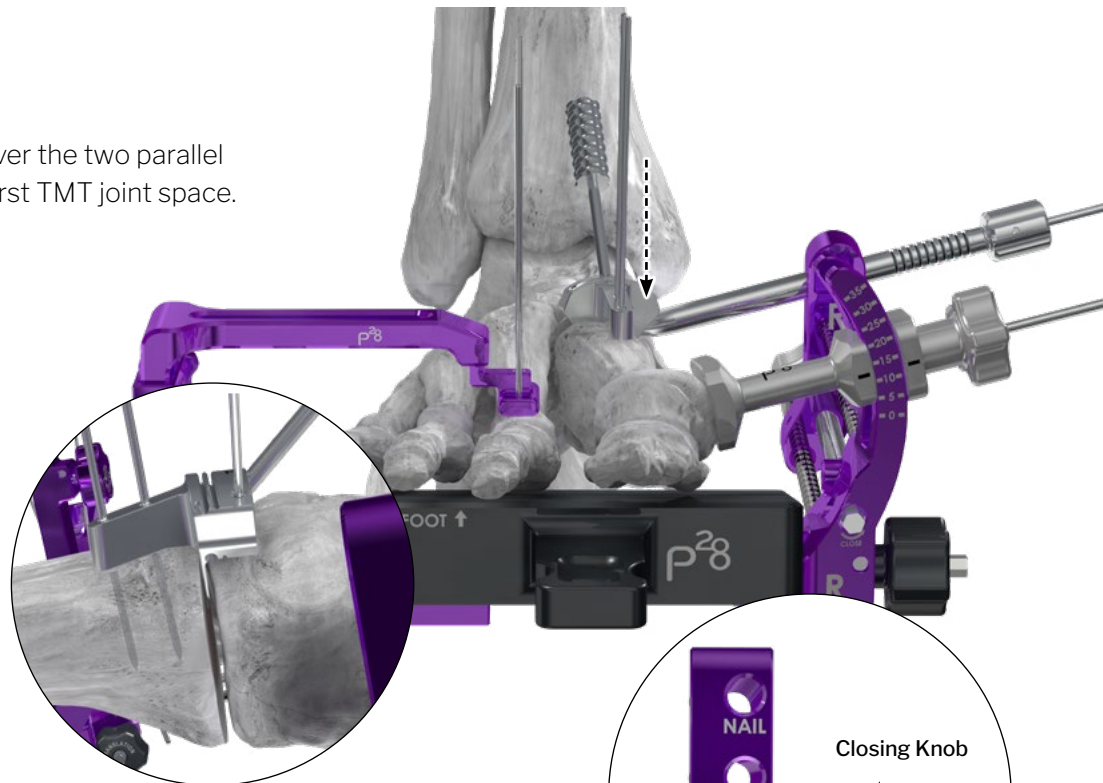
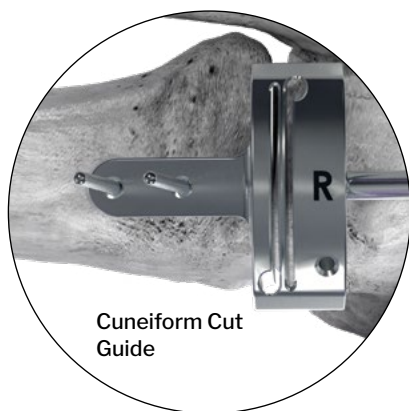

Rotate the Closing Knob clockwise to close any gap in the joint **but do not compress the joint as this will alter the cut guide position.** Confirm the cut location and orientation with fluoroscopy, looking through the cut guide in a dorsal-plantar view to preview the cut distance and orientation into the cuneiform.

CUNEIFORM CUT:

Insert one oblique Ø1.40 mm K-wire through the Cut Guide and into the cuneiform to secure.

Use the saw blade to perform the cuneiform cut through the desired slot on the Cut Guide, cutting from a dorsal approach and with a sweeping method to ensure appropriate cutting of the cuneiform dorsally, laterally, and plantarly. It is recommended to cut through the most distal cut slot first to avoid excessive shortening of the first ray.

Remove the oblique Ø1.40 mm K-wire and pull the Cut Guide out of the joint, leaving the remaining two Ø1.40 mm K-wires in place. Clean up the joint space, removing the bone wafer and residual fragments. Remove the cut surfaces of the cuneiform subchondral bone and cartilage from the joint using a preferred technique. Confirm that all residual bone fragments are removed from the joint.

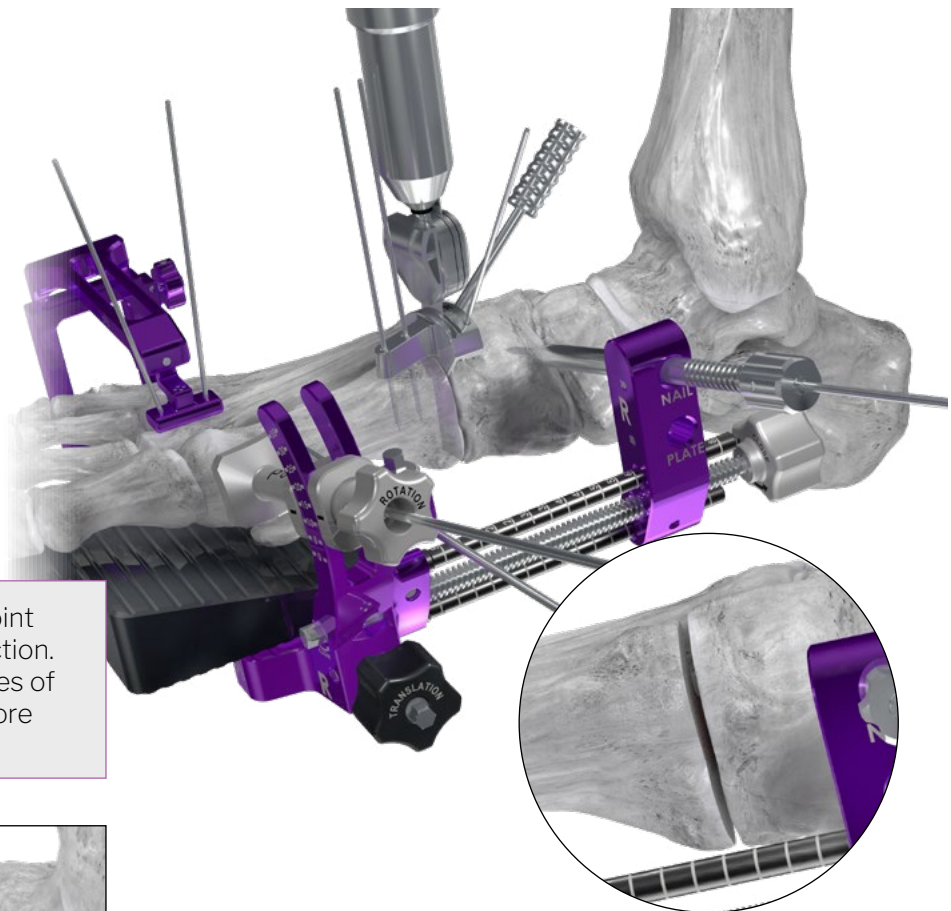
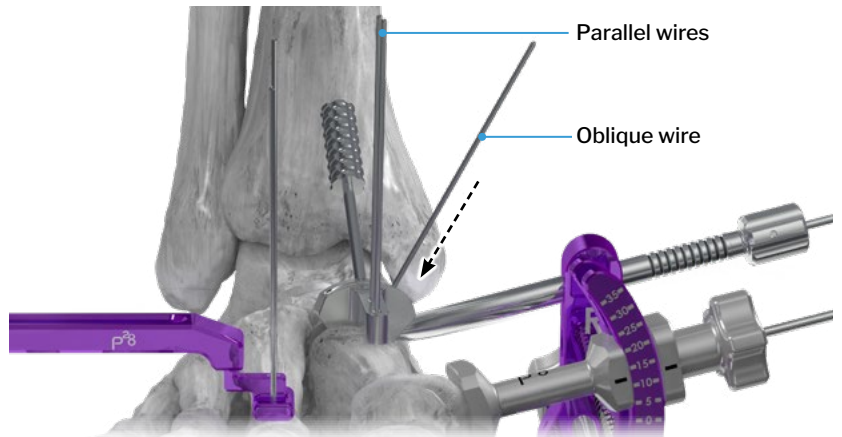

IMPORTANT: Proper cleanup of this joint space is required for successful correction. Ensure that there are no lingering pieces of bone and/or cartilage in the space before moving on to the next step.



If additional cutting is needed, slide the Cut Guide back on over the K-wires and turn the Closing Knob clockwise to close any gap in the joint **without applying compression**. Perform an additional cuneiform cut through the proximal slot of the Cut Guide, then remove the cut bone and cartilage as described above.

The Closing Knob can be turned counterclockwise to distract the joint space and assist in joint preparation, if needed.

JOINT CLOSURE:

When the cuneiform cut is completed, remove the two parallel Ø1.40 mm K-wires. Fenestration of the cut surfaces can be performed per surgeon preference, rotating the Closing Knob counterclockwise to open the joint to provide access. Rotate the Closing Knob clockwise until the joint space is closed and the cut surfaces are apposed, assessing joint positioning. Slight manual manipulation of the metatarsal base may be needed to align the cut surfaces if plantar or dorsal translation is observed. If gapping is observed, use the saw blade to “feather cut” the cut surfaces until proper apposition is achieved.

IMPORTANT: This step is only to bring the cut surfaces into an apposed, closed-joint position. Compression should not be applied at this time, as it will be achieved with the plate- or nail-based final fixation to follow.

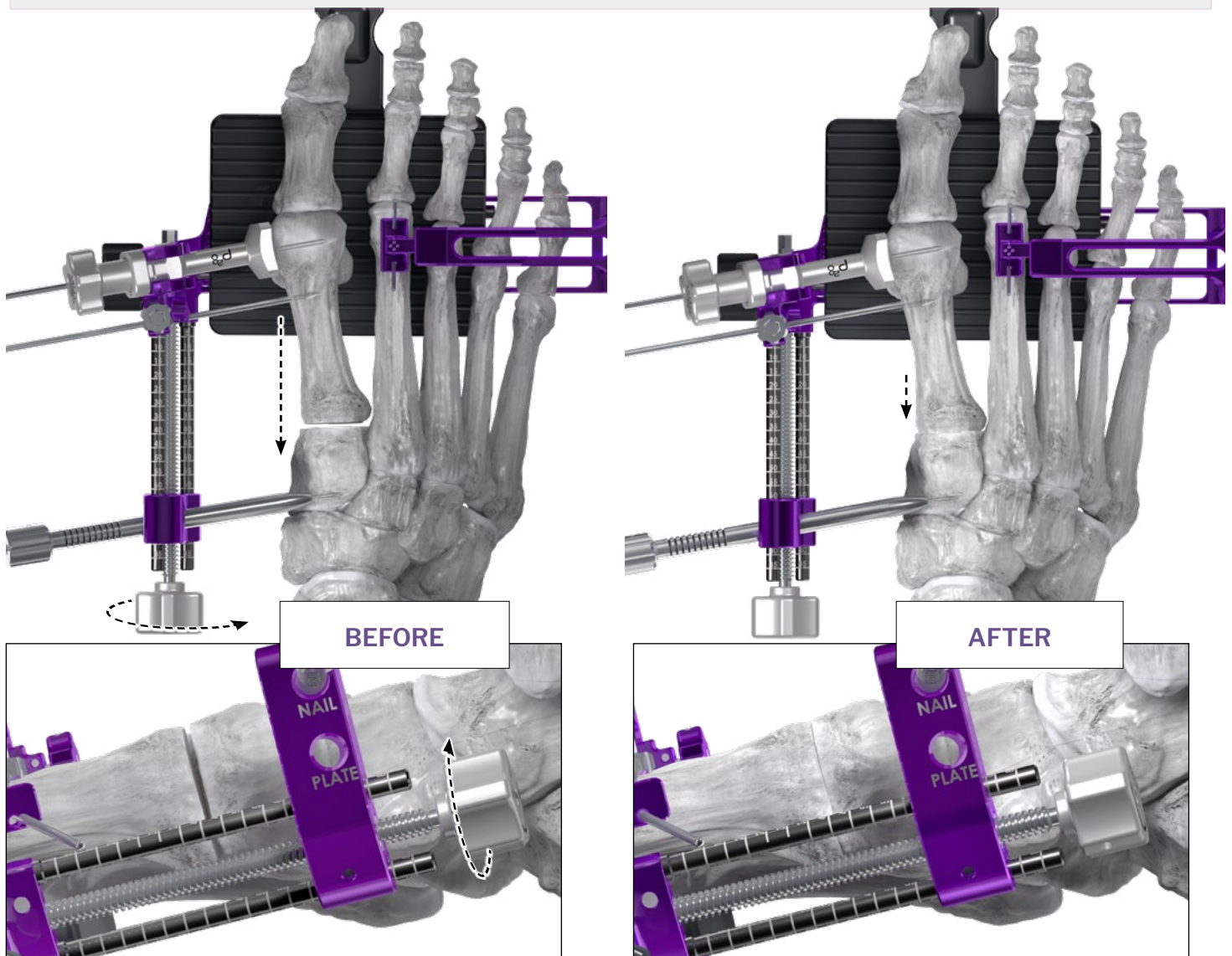

The Windlass mechanism can be used to assist if desired. The MTP joint may be temporarily impaired by the clamp, therefore do not assess correction by this range of motion.

NOTE: If the base of the metatarsal appears to be shifting medially after reduction, it is recommended to resect the lateral aspect of the metatarsal base (see page 14).

Surgical Technique - Final Fixation

Once correction is finalized and held in place by the clamp, proceed to plate- or nail-based fixation. The clamp was designed for spatial compatibility with the Paragon 28 Phantom® Intramedullary Nail and Gorilla® Lapidus Plate implants and instrumentation.

PHANTOM® INTRAMEDULLARY NAIL SYSTEM FINAL FIXATION:

Follow the Phantom Intramedullary Nail System STG (P30-STG-0001), using the previously placed sphere wire for Polyaxial Targeting Guide attachment. If the Targeting Guide is impeded by the clamp when trying to achieve the correct alignment, follow the appropriate solution directed in Table 1 (A-B) on page 21.

Polyaxial Targeting Guide attachment

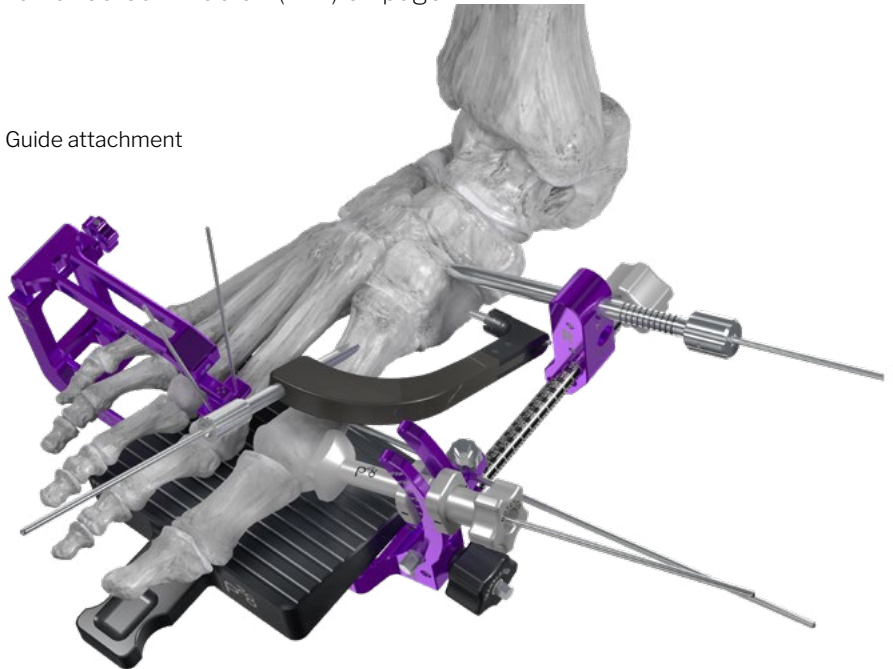

Once the proper Targeting Guide alignment is achieved, continue following the Nail System technique. If the Clamp interferes with the placement of the Threaded Peg(s), follow the appropriate solution directed in Table 1 (C-D) on page 21.

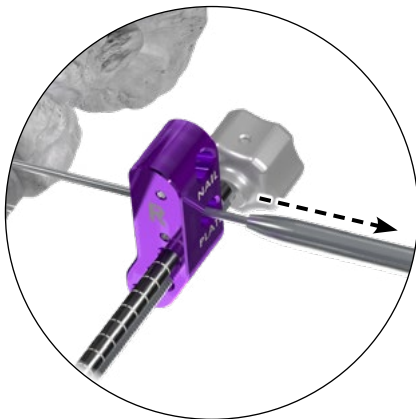

Before performing the Nail System Compression steps, remove the clamp cuneiform K-wire Tube to prevent the clamp from hindering compression.

Outrigger attachment

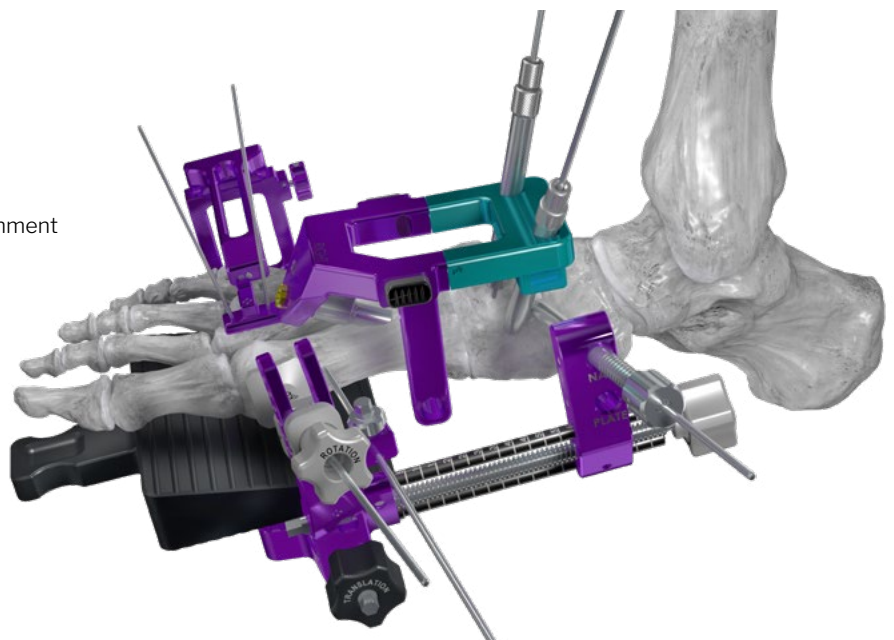

Once Proximal Fixation and Compression have been achieved, the clamp can be removed from the anatomy without affecting correction if it impedes the placement of the distal Threaded Peg.

PHANTOM® INTRAMEDULLARY NAIL SYSTEM FINAL FIXATION: _____

Complete the remainder of the Nail System technique to secure the fixation, then remove the clamp if still attached. Proceed to incision closure or concomitant procedures at this time.

Table 1: Nail Situational Tips

Guide impeded by:		Solution
A	Second metatarsal wires	Second metatarsal wires can be cut or bent out of the way
B	Metatarsal Paddle and associated K-wire	Place a joint-spanning Ø2.30 mm K-wire (Figure 1), then remove the Clamp 1 st metatarsal K-wire and Metatarsal Paddle This wire must be removed prior to performing the Nail Compression steps
Peg(s) Impeded by:		Solution
C	Cuneiform K-wire and/or Tube (Proximal Pegs)	Place a joint-spanning Ø2.30 mm K-wire (Figure 1), if not previously placed), then remove the Clamp cuneiform K-wire and Tube This wire must be removed prior to performing the Nail Compression steps
D	Metatarsal Paddle and associated K-wire	Place a joint-spanning Ø2.30 mm K-wire (Figure 1), then remove the Clamp 1 st metatarsal K-wire and Metatarsal Paddle This wire must be removed prior to performing the Nail Compression steps

Figure 1: Joint-spanning wire trajectory for Nail fixation

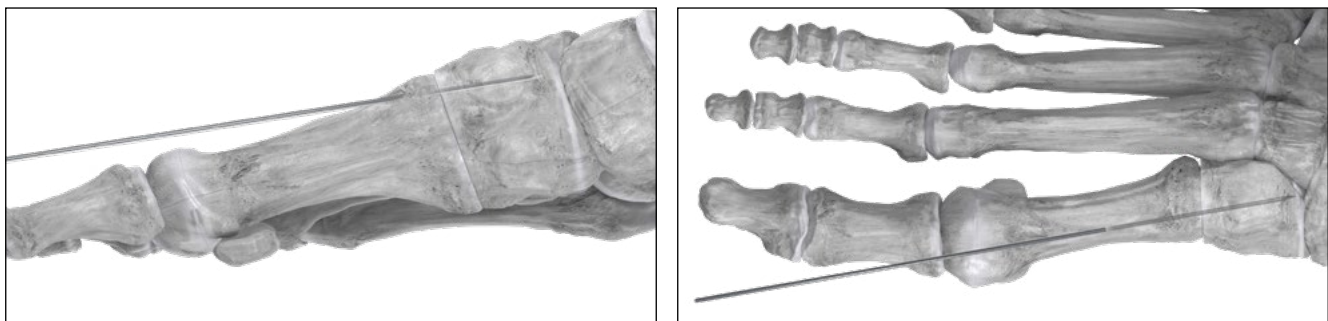

FINAL FIXATION GORILLA® LAPIDUS PLATING SYSTEM:

Follow the Gorilla Lapidus Plating System STG (P51-STG-0003) to position and attach the plate across the TMT joint space. If the Precision Guide is impeded by the clamp during plate positioning, follow the appropriate solution in Table 2 (A-B) on page 23.

K-wire placement with Precision Guide

Once the proper plate positioning is achieved, continue following the Plating System technique.

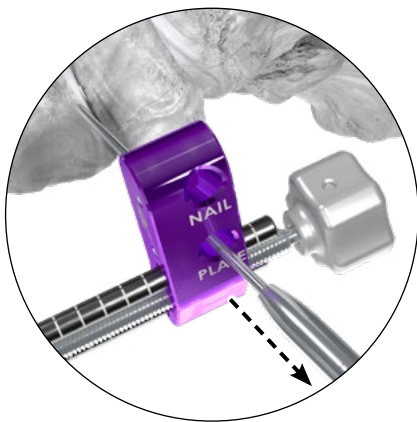
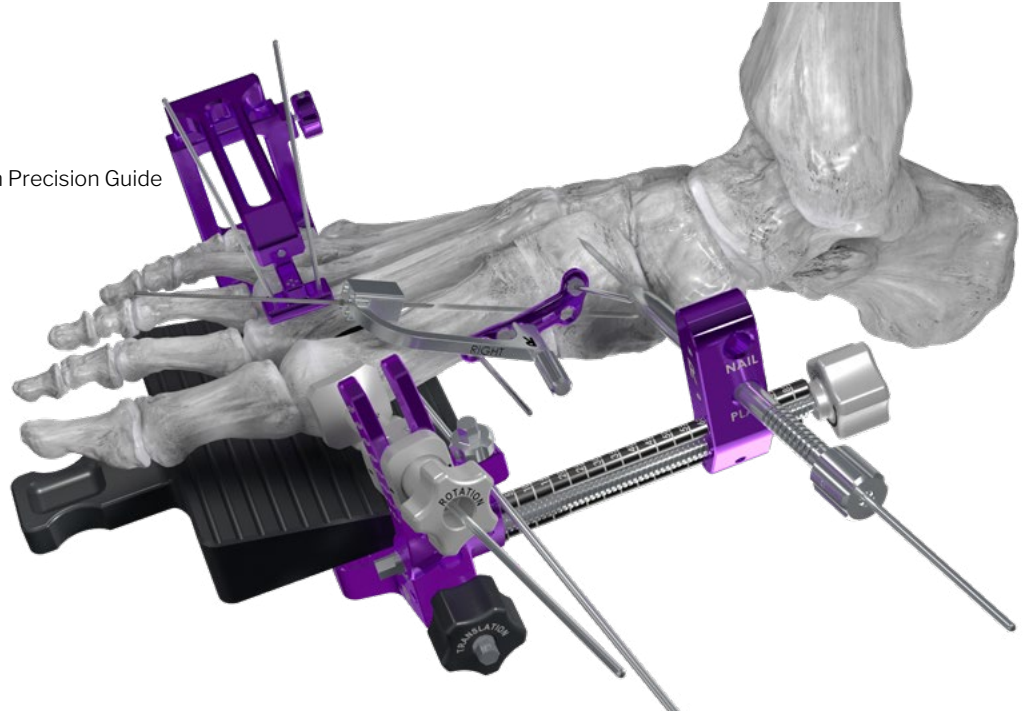

After the crossing screw is inserted across the joint, but prior to applying compression, remove the clamp cuneiform K-wire Tube to prevent the clamp from hindering compression.

If plate screw placement is impeded by the clamp, follow the appropriate solution in Table 2 (C) on page 23.

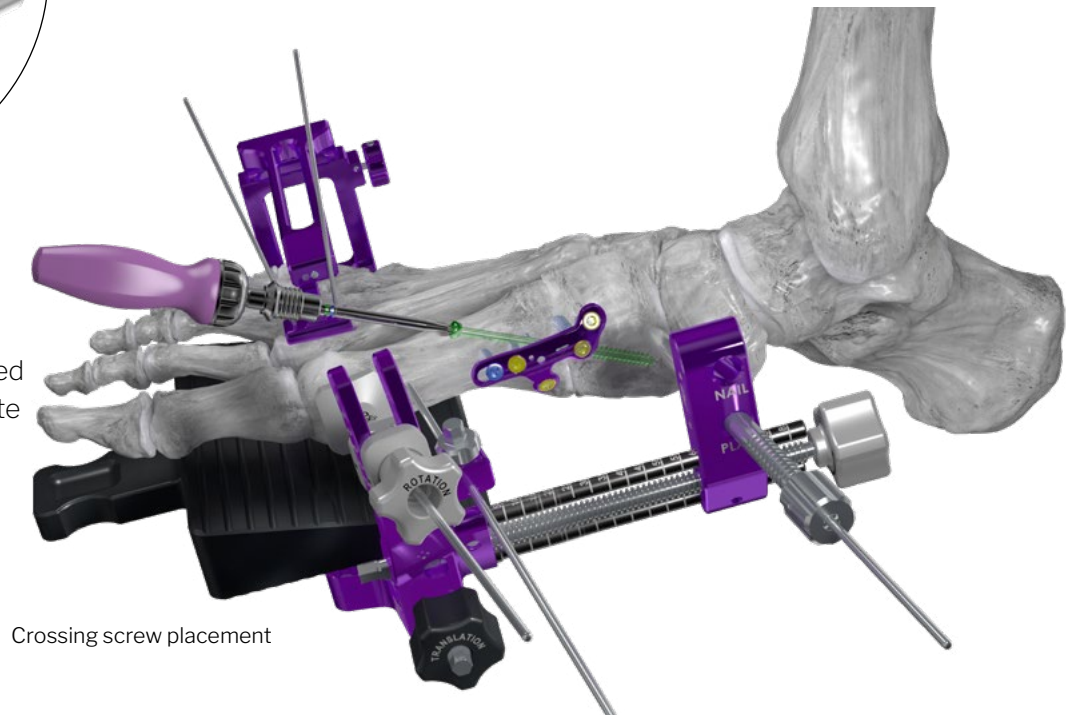

Crossing screw placement

FINAL FIXATION GORILLA® LAPIDUS PLATING SYSTEM: _____

Complete the remainder of the Plating System technique to secure the fixation, then remove the clamp if still attached. Proceed to incision closure or concomitant procedures at this time.

Table 2: Nail Situational Tips

Guide impeded by:		Solution
A	Second metatarsal wires	Second metatarsal wires can be cut or bent out of the way
B	Metatarsal Paddle and associated K-wire	Place a joint-spanning Ø2.30 mm K-wire (Figure 2) then remove the Clamp 1 st metatarsal K-wire and Metatarsal Paddle This wire must be removed after the crossing screw is inserted across the joint, but prior to applying compression
Peg(s) Impeded by:		Solution
C	Compression Rods	Use longer HX10 driver provided. If still difficult, the Clamp can be removed following crossing screw placement

Figure 2: Joint-spanning wire trajectory for plate fixation

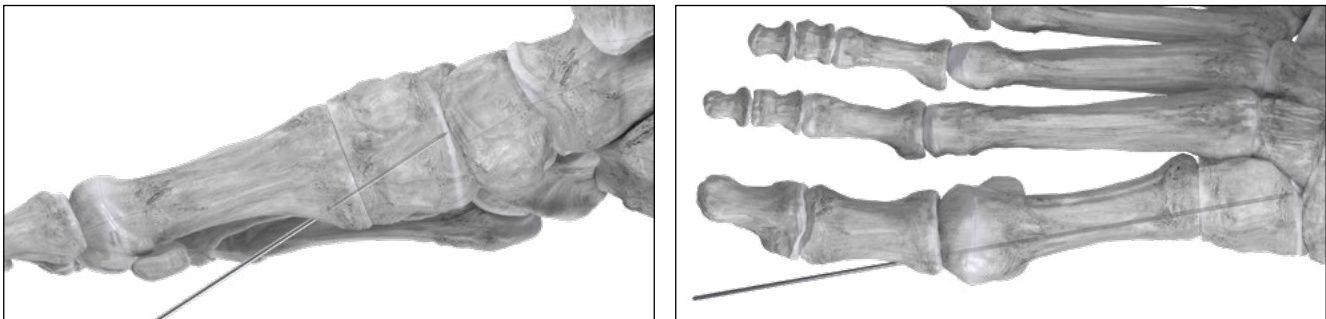

CADDY LAYOUT: _____

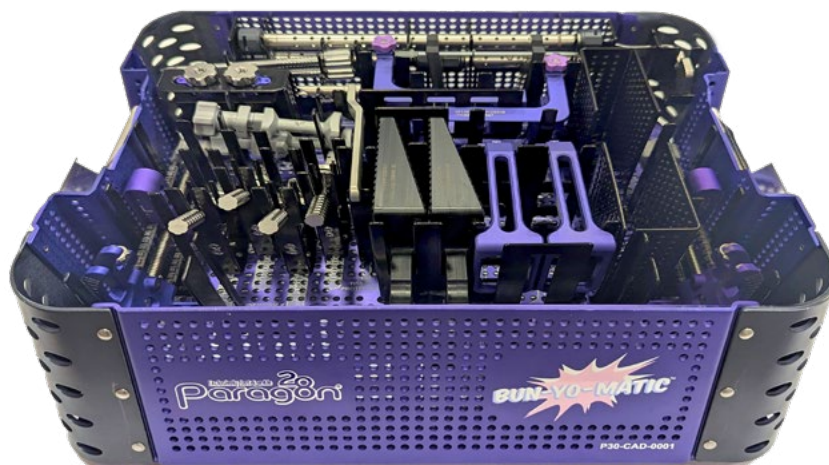

TIP: Apply surgical milk to the threaded rods to improve thread motion.

Surgical Technique - Caddy Layout and Contents

CADDY CONTENTS:

Part #	Description	Use
P30-100-5310	Lapidus Nail Tissue Protector, Rotated 90	Reusable
P30-196-2319	Bun-Yo-Matic, K-wire, Ø2.30mm x 19cm, Smooth	Single-use
P30-960-1201L	Bun-Yo-Matic, Rotator, Left	Reusable
P30-960-1201R	Bun-Yo-Matic, Rotator, Right	Reusable
P30-960-1202L	Bun-Yo-Matic, Lateral Adjuster, Left	Reusable
P30-960-1202R	Bun-Yo-Matic, Lateral Adjuster, Right	Reusable
P30-960-1203	Bun-Yo-Matic, Lateral Hook	Reusable
P30-960-1207	Bun-Yo-Matic, 1 st Met Wire Guide	Reusable
P30-960-1208	Bun-Yo-Matic, Wire Tube	Reusable
P30-960-1210	Bun-Yo-Matic, Met Grip Wire Guide	Reusable
P30-960-1211	Bun-Yo-Matic, Weight Bearing Wedge	Reusable
P30-960-1212L	Bun-Yo-Matic, Met Cut Guide, Left	Reusable
P30-960-1212R	Bun-Yo-Matic, Met Cut Guide, Right	Reusable
P30-960-1213L	Bun-Yo-Matic, Cuneiform Cut Guide, Left	Reusable
P30-960-1213R	Bun-Yo-Matic, Cuneiform Cut Guide, Right	Reusable
P30-960-1214	Bun-Yo-Matic, Anti-Penetration Tool	Reusable
P31-941-0000	K-wire Tube, Cap	Reusable
P31-941-0080	K-wire Tube, 80mm MAX	Reusable
P31-941-0100	K-wire Tube, 100 mm MAX	Reusable
P31-941-0200	K-wire Tube, 200 mm MAX	Reusable
P99-151-P301-S	Saw Blade 39 x 10 x 0.4/0.6 mm, MicroAire (Sterile)	Single-use
P99-151-P302-S	Saw Blade 39 x 10 x 0.4/0.6 mm, Stryker (Sterile)	Single-use
P99-191-LT10	Solid Driver, HX10 x 138mm	Reusable
P99-192-1410	K-wire, Ø1.40 mm x 10 cm	Single-use
P99-251-1604	K-Wire, Olive, Threaded, Ø1.80 mm x 4.7 cm	Single-use



When using the Bun-Yo-Matic with a SMART Bun-Yo-MaticSM Case Plan, the report will provide suggested correction amounts for the translation and rotation steps based on the correction identified by the surgeon pre-operatively with the SMART Bun-Yo-MaticSM Portal. Use the associated measurement readings on the clamp to assess and perform such corrections advised by the SMART Bun-Yo-MaticSM Case Plan.

IMA ADJUSTMENT:

The following are example SMART Bun-Yo-MaticSM corrections only and are not to be used as general correction guidance.

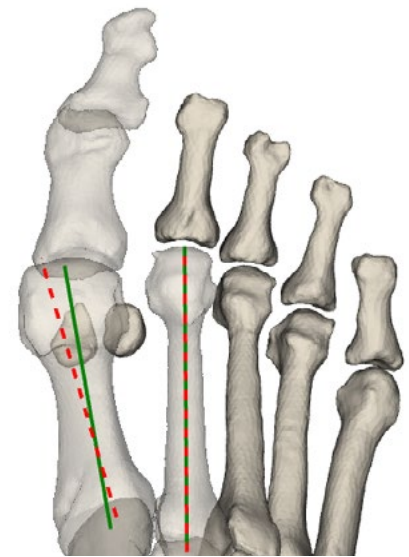
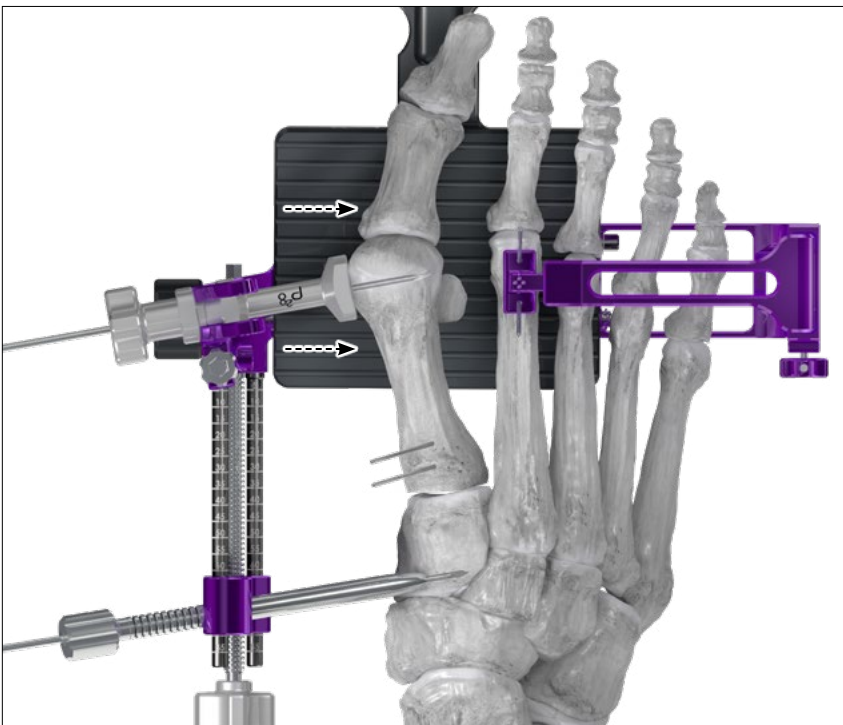

IMA Adjustment	
1 st and 2 nd Intermetatarsal Angle	
Pre-Op:	15.8°
Target:	9.5°
Bun-Yo-Matic TM Translation: 4 mm	



NOTE: Correction amounts for both IMA and rotation reflect amount of change, not final position.

Example: for this IMA correction, turn the Translation knob clockwise until the medial edge of the Lateral Adjuster has moved 4 mm medially on the threaded rods. Each hash mark equals 1 mm, with labels every 5 mm.

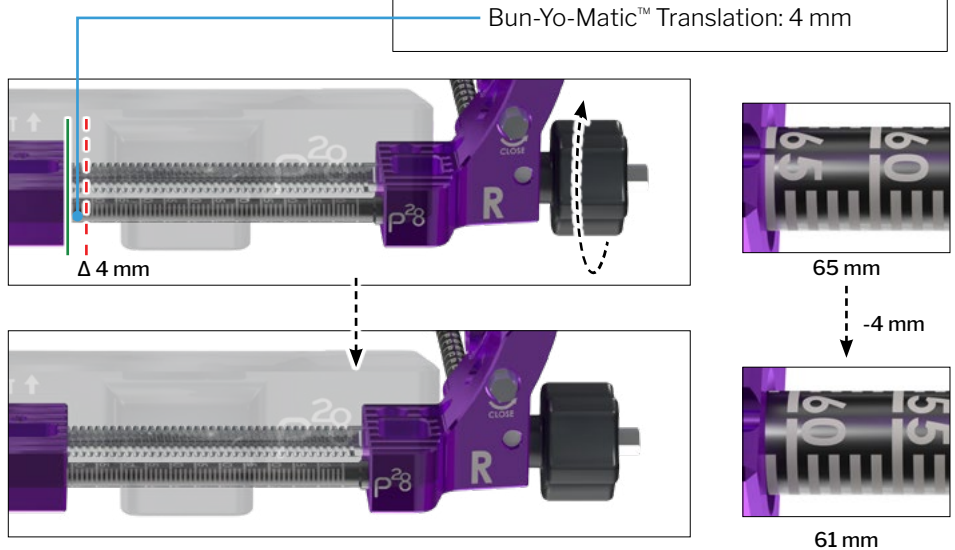

ROTATION ADJUSTMENT:

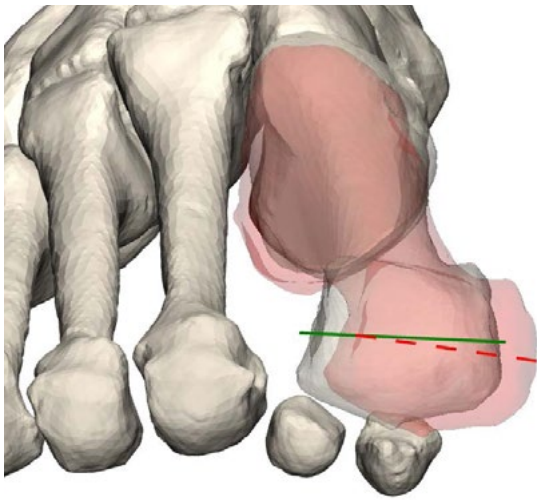

1st Metatarsal Rotation Adjustment

Pre-Op: 7.2°

Target: 2.3°

Bun-Yo-Matic™ Rotation: 5.0°
(Supination)

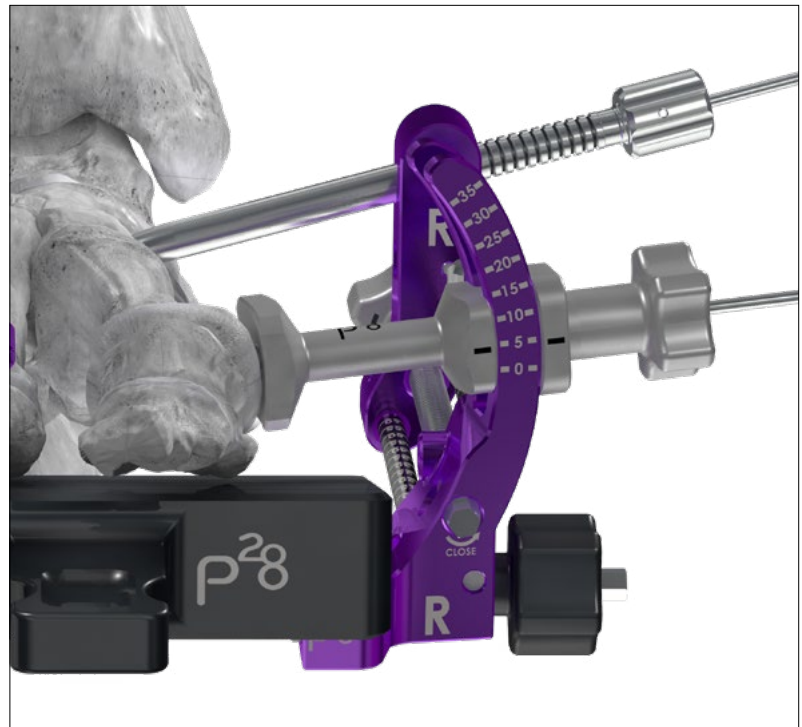
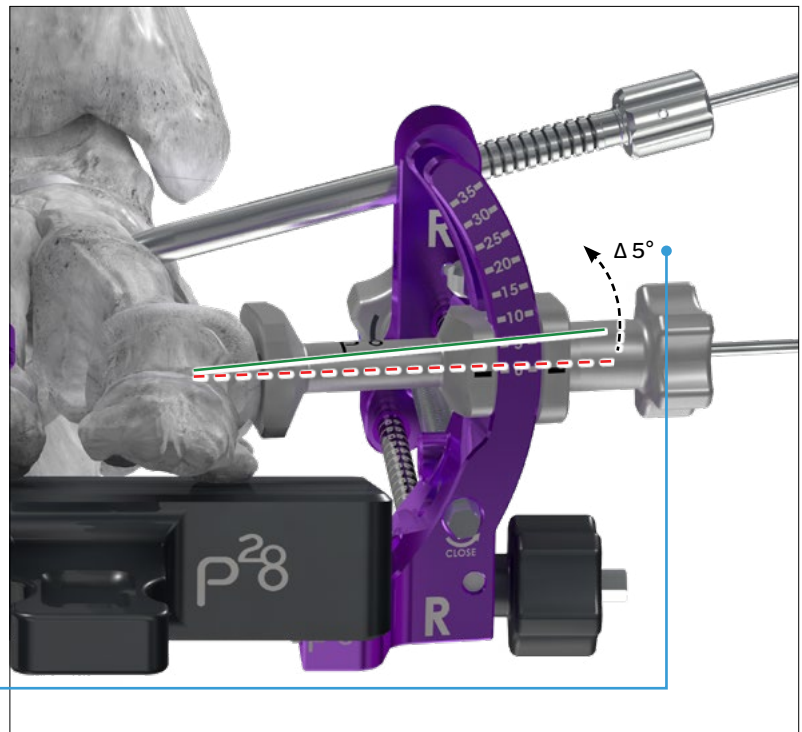

NOTE: Correction amounts for both IMA and rotation reflect amount of change, not final position.

Example: for this rotation correction, slide the Metatarsal paddle dorsally up the rotator arm until it is 5° greater than it was initially. Markings indicate 5° increments of rotation.

Refer to www.paragon28.com/ifus for the complete and most current instructions for use document.

INDICATIONS FOR USE (PHANTOM®)

The Phantom® Small Bone Intramedullary Nail System is indicated for use in stabilization and fixation of the small bones of the feet and ankle for the treatment of fractures, osteotomies, nonunions, pseudoarthroses and malunions by revision, joint fusion or reconstruction procedures.

CONTRAINDICATIONS

The Paragon 28® Phantom® Small Bone Intramedullary Nail System implants are not designed or sold for any use except as indicated. Use of the Phantom® Small Bone Intramedullary Nail System is contraindicated in the following situations:

- Active, suspected or latent infection in the affected area
- Patients who are physiologically or psychologically inadequate
- Patients previously sensitized to titanium
- Longitudinal splits or longitudinal fractures
- Insufficient quantity or quality of bone to permit stabilization, conditions that retard healing (not including pathological fractures) and conditions causing poor blood supply
- Open epiphyseal plates
- In patients where there is a possibility for conservative treatment
- Corpulence; an overweight or corpulent patient can strain the implant to such a degree that stabilization or implant failure can occur
- Indications not included in the INDICATIONS FOR USE

POTENTIAL COMPLICATIONS AND ADVERSE REACTIONS

In any surgical procedure, the potential for complications and adverse reactions exist. The risks and complications with these implants include:

- Loosening, deformation or fracture of the implant
- Acute post-operative infections and late infections with possible sepsis
- Migration, subluxation of the implant with resulting reduction in range of movement
- Fractures resulting from unilateral joint loading
- Thrombosis and embolism
- Wound hematoma and delayed wound healing
- Temporary and protracted functional neurological perturbation
- Tissue reactions as a result of allergy or foreign body reaction to dislodged particles
- Corrosion with localized reaction and pain
- Pain, a feeling of malaise or abnormal sensations due to the implant used
- Bone loss due to stress shielding

All possible complications listed here are not typical of Paragon 28®, Inc. products but are in principle observed with any implant. Promptly inform Paragon 28®, Inc. as soon as complications occur in connection with the implants or surgical instruments used. In the event of premature failure of an implant in which a causal relationship with its geometry, surface quality or mechanical stability is suspected, please provide Paragon 28®, Inc. with the explant(s) in a cleaned, disinfected and sterile condition. Paragon 28®, Inc. cannot accept any other returns of used implants. The surgeon is held liable for complications associated with inadequate asepsis, inadequate preparation of the osseous implant bed in the case of implants, incorrect indication or surgical technique or incorrect patient information and consequent incorrect patient behavior.

WARNINGS AND PRECAUTIONS

- Re-operation to remove or replace implants may be required at any time due to medical reasons or device failure. If corrective action is not taken, complications may occur.
- Use of an undersized implant in areas of high functional stresses may lead to implant fracture and failure.
- Plates and screws, wires, or other appliances of dissimilar metals should not be used together in or near the implant site.
- The implants and guide wires are intended for single use only.
- Instruments, guide wires and screws are to be treated as sharps.
- **Do not use other manufacturer's instruments or implants in conjunction with the Phantom® Small Bone Intramedullary Nail System**

REUSABLE INSTRUMENT REPROCESSING INSTRUCTIONS

For the reprocessing instructions for the Bun-Yo-Matic Lapidus Clamp, refer to the Reprocessing Instructions (P30-CLN-0001). These are also available by calling 855-786-2828

Indications, Contraindications and Warnings

Refer to www.paragon28.com/ifus for the complete and most current instructions for use document.

INDICATIONS FOR USE (PHANTOM®)

MRI SAFETY INFORMATION



A patient with the Paragon 28® Phantom® Small Bone Intermedullary Nail System may be safely scanned under the following conditions. Failure to follow these conditions may result in injury to the patient.

Name/Identification of device	Paragon 28® Phantom® Small Bone Intramedullary Nail System
Nominal value(s) of Static Magnetic Field [T]	1.5 T or 3 T
Maximum Spatial Field Gradient [T/m and gauss/cm]	30 T/m (3000 gauss/cm)
RF Excitation	Circularly Polarized (CP)
RF Transmit Coil Type	Whole body transmit coil, Head RF transmit-receive coil
Maximum Whole Body SAW [W/kg]	2.0 W/kg (Normal Operating Mode)
Limits on Scan Duration	2.0 W/kg whole body average SAR for 60 minutes of continuous RF (a sequence or back to back series/scan without breaks)
If information about a specific parameter is not included, there are no conditions associated with that parameter.	

Refer to www.paragon28.com/ifus for the complete and most current instructions for use document.

INDICATIONS FOR USE (GORILLA®)

The Baby Gorilla®/Gorilla® Bone Plates and Bone Screws of the Baby Gorilla®/Gorilla® Plating System are indicated for use in stabilization and fixation of fractures or osteotomies; intra and extra articular fractures, joint depression, and multi-fragmentary fractures; revision procedures, joint fusion and reconstruction of small bones of the toes, feet and ankles including the distal tibia, talus, and calcaneus, as well as the fingers, hands, and wrists. The system can be used in both adult and pediatric patients. Specific examples include:

Forefoot:

- Arthrodesis of the 1st metatarsalcuneiform joint (Lapidus Fusion)
- Metatarsal or phalangeal fractures and osteotomies
- Lesser metatarsal shortening osteotomies (e.g. Weil)
- Fifth metatarsal fractures (e.g. Jones Fracture)

Mid/Hindfoot:

- LisFranc Arthrodesis and/or Stabilization
- 1st (Lapidus), 2nd, 3rd, 4th, and 5th Tarsometatarsal (TMT) Fusions
- Intercuneiform Fusions
- Navicular-Cuneiform (NC) Fusion
- Talo-Navicular (TN) Fusion
- Calcaneo-Cuboid (CC) Fusion
- Subtalar Fusion
- Medial Column Fusion
- Cuneiform Fracture
- Cuboid Fracture
- Navicular Fracture

Ankle:

- Lateral Malleolar Fractures
- Syndesmosis Injuries
- Medial Malleolar Fractures and Osteotomies
- Bi-Malleolar Fractures
- Tri-Malleolar Fractures
- Posterior Malleolar Fractures
- Distal Anterior Tibia Fractures
- Vertical Shear Fractures of the Medial Malleolus
- Pilon Fractures
- Distal Tibia Shaft Fractures
- Distal Fibula Shaft Fractures
- Distal Tibia Periarticular Fractures
- Medial Malleolar Avulsion Fractures
- Lateral Malleolar Avulsion Fractures
- Tibiotalocalcaneal Joint Arthrodesis
- Tibiotalar Joint Arthrodesis
- Tibiocalcaneal Arthrodesis
- Supramalleolar Osteotomy
- Fibular Osteotomy

1st metatarsal osteotomies for hallux valgus correction including:

- Opening base wedge osteotomy
- Closing base wedge osteotomy
- Crescentic Osteotomy
- Proximal Osteotomy (Chevron and Rotational Oblique)
- Distal Osteotomy (Chevron/Austin)

Arthrodesis of the 1st metatarsophalangeal joint (MTP) including:

- Primary MTP Fusion due to hallux rigidus and/or hallux valgus
- Revision MTP Fusion
- Revision of failed 1st MTP Arthroplasty implant

Flatfoot:

- Lateral Column Lengthening (Evans Osteotomy)
- Plantar Flexion Opening Wedge Osteotomy of the Medial Cuneiform (Cotton Osteotomy)
- Calcaneal Slide Osteotomy

Charcot:

- Medial column fusion (talus, navicular, cuneiform, metatarsal) for neuropathic osteoarthropathy (Charcot)
- Lateral column fusion (calcaneus, cuboid, metatarsal) for neuropathic osteoarthropathy (Charcot)

In addition, the non-locking, titanium screws and washers are indicated for use in bone reconstruction, osteotomy, arthrodesis, joint fusion, fracture repair and fracture fixation, appropriate for the size of the device.

Indications, Contraindications and Warnings

Refer to www.paragon28.com/ifus for the complete and most current instructions for use document.

CONTRAINDICATIONS

Use of the Baby Gorilla®/Gorilla® Plating System is contraindicated in cases of inflammation, cases of active or suspected sepsis/infection and osteomyelitis; or in patients with certain metabolic diseases.

All applications that are not defined by the indications are contraindicated. In addition, surgical success can be adversely affected by:

- Acute or chronic infections, local or systemic
- Vascular, muscular or neurological pathologies that compromise the concerned extremity
- All concomitant pathologies that could affect the function of the implant
- Osteopathies with reduced bone substance that could affect the function of the implant
- Any mental or neuromuscular disorder that could result in an unacceptable risk of failure at the time of fixation or complications in post-operative treatment
- Known or suspected sensitivity to metal
- Corpulence; an overweight or corpulent patient can strain the implant to such a degree that stabilization or implant failure can occur
- Whenever the use of the implant comes into conflict with the anatomical structures of physiological status

Other medical or surgical pre-conditions that could compromise the potentially beneficial procedure, such as:

- The presence of tumors
- Congenital abnormalities
- Immunosuppressive pathologies
- Increased sedimentation rates that cannot be explained by other pathologies
- Increased leukocyte (WBC) count
- Pronounced left shift in the differential leukocyte count

POTENTIAL COMPLICATIONS AND ADVERSE REACTIONS

In any surgical procedure, the potential for complications and adverse reactions exist. The risks and complications with these implants include:

- Loosening, deformation or fracture of the implant
- Acute post-operative wound infections and late infections with possible sepsis
- Migration, subluxation of the implant with resulting reduction in range of movement
- Fractures resulting from unilateral joint loading
- Thrombosis and embolism
- Wound hematoma and delayed wound healing

- Temporary and protracted functional neurological perturbation
- Tissue reactions as the result of allergy or foreign body reaction to dislodged particles
- Corrosion with localized tissue reaction and pain
- Pain, a feeling of malaise or abnormal sensations due to the implant used
- Bone loss due to stress shielding

All possible complications listed here are not typical of Paragon 28®, Inc. products but are in principle observed with any implant. Promptly inform Paragon 28®, Inc. as soon as complications occur in connection with the implants or surgical instruments used. In the event of premature failure of an implant in which a causal relationship with its geometry, surface quality or mechanical stability is suspected, please provide Paragon 28®, Inc. with the explant(s) in a cleaned, disinfected and sterile condition. Paragon 28®, Inc. cannot accept any other returns of used implants. The surgeon is held liable for complications associated with inadequate asepsis, inadequate preparation of the osseous implant bed in the case of implants, incorrect indication or surgical technique or incorrect patient information and consequent incorrect patient behavior.

WARNINGS AND PRECAUTIONS

- Re-operation to remove or replace implants may be required at any time due to medical reasons or device failure. If corrective action is not taken, complications may occur.
- Use of an undersized plate or screw in areas of high functional stresses may lead to implant fracture and failure.
- Plates and screws, wires, or other appliances of dissimilar metals should not be used together in or near the implant site.
- The implants and guide wires are intended for single use only.
- Instruments, guide wires and screws are to be treated as sharps.
- Do not use other manufacturer's instruments or implants in conjunction with the Baby Gorilla®/Gorilla® Plating System.
- If a stainless steel Gorilla® R3LEASE™ Screw is used, it may only be used standalone.
- The device should only be used in pediatric patients where the growth plates have fused or in which active growth plates will not be crossed by the system implants or instrumentation.

MR SAFETY INFORMATION

The Baby Gorilla®/Gorilla® Plating System has not been evaluated for safety and compatibility in the MR environment. It has not been tested for heating, migration, or image artifact in the MR environment. The safety of Baby Gorilla®/Gorilla® Plating System in the MR environment is unknown. Scanning a patient who has this device may result in patient injury.



SURGICAL TECHNIQUE GUIDE Bun-Yo-Matic™ Lapidus Clamp System

P30-STG-0006 RevD [2024-07-25]

™Trademarks and ®Registered Marks of Paragon 28®, Inc.
© Copyright 2024 Paragon 28®, Inc. All rights reserved.
Patents: www.paragon28.com/patents

Paragon 28®, Inc.
14445 Grasslands Dr.
Englewood, CO 80112 USA
(855) 786-2828 🇺🇸

Exclusively foot & ankle
Paragon[®] 28
www.Paragon28.com

Disclaimer:

The purpose of the Bun-Yo-Matic™ Lapidus Clamp System Technique Guide is to demonstrate the optionality and functionality of the Bun-Yo-Matic™ Lapidus Clamp System implants and instrumentation. CAUTION: Federal Law (USA) restricts this device to sale and use by, or on the order of, a physician