



SURGICAL TECHNIQUE GUIDE

Naviculocuneiform Arthrodesis

NC Plating System

GORILLA[®]
R3CON PLATING SYSTEM

Acknowledgment:

Paragon 28® would like to thank Byron Hutchinson, DPM for his contribution to the development of the surgical technique guide.

PRODUCT DESCRIPTION

Paragon 28® designed the Gorilla® NC Plating System to provide fixation in a similar manner to a three screw construct for NC fusion, with the benefit of plate and locking screw fixation. The patent-pending NC plate with Precision™ Guide technology allows for a crossing screw that passes from the medial cuneiform to the lateral aspect of the navicular. A locking screw in the plate allows for fixation between the proximal medial navicular to the intermediate cuneiform. A second locking screw in the navicular helps guard against plantar gapping, while two distal screws in the medial cuneiform have the ability to be placed across one, two or three cuneiforms.

IMPLANT OFFERING

NC Plates - Right (shown) and Left Side Specific



Small



Medium



Large



X-Large

Templates - Right (shown) and Left Side Specific



Small



Medium



Large



X-Large

Reamer



Precision™ Guide NC Plate



Set Screw



K-wire Sleeve 1.6 mm



K-wire Sleeve 1.4 mm



K-wire Sleeve 1.2 mm



Monster® 5.5 mm Screw

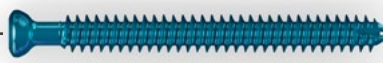

Monster® 4.5 mm Screw



Mini-Monster® 4.0 mm Screw



Mini-Monster® 3.5 mm Screw

INCISION/EXPOSURE

Supine patient positioning with fluoroscopy available is preferred for this technique. An incision is made in the interval between the tibialis anterior and tibialis posterior tendons over the naviculocuneiform ("NC joint"). Dissection is carried down to the medial cuneiform and navicular to expose the medial surfaces of these bones.

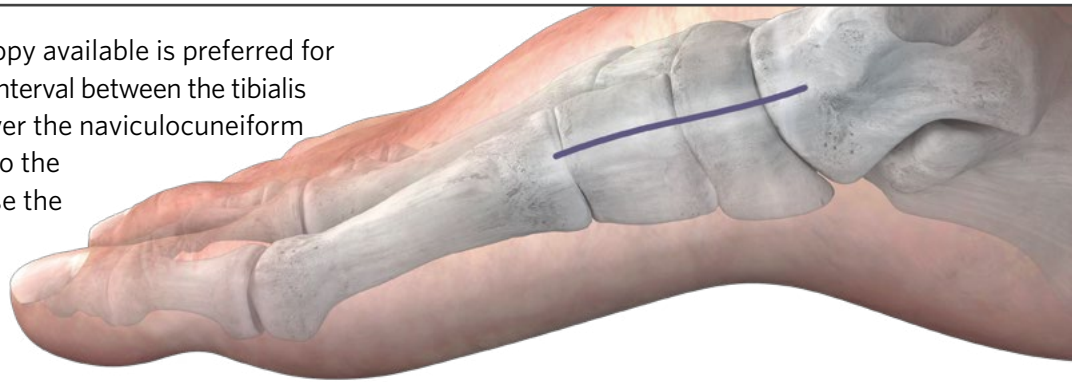

JOINT PREPARATION

Remove the cartilage from the navicular and medial cuneiform using a preferred technique. If necessary, remove cartilage from the intermediate cuneiform/navicular joint, intercuneiform joints and/or lateral cuneiform/navicular joint.



Subchondral Drill



Bone Chisel

A subchondral drill and bone chisel are available in the Gorilla R3CON Instrument Caddy to help facilitate joint preparation. The subchondral drill offers 10 mm of perforation into the bone while the chisel is used with the mallet to connect subchondral drill holes or feather the subchondral bone.

TEMPORARY FIXATION

Temporary fixation can be achieved across the medial cuneiform/navicular joint by placing a K-wire from dorsal distal to plantar proximal across the medial cuneiform and navicular after appropriate joint positioning. The Windlass mechanism can be applied while placing temporary fixation to allow for compression between the medial cuneiform and navicular.

Alternatively, external compression can be applied across the joint for temporary stabilization (see page 8 for "EXTERNAL COMPRESSION USING A FULLY THREADED CROSS SCREW" technique).

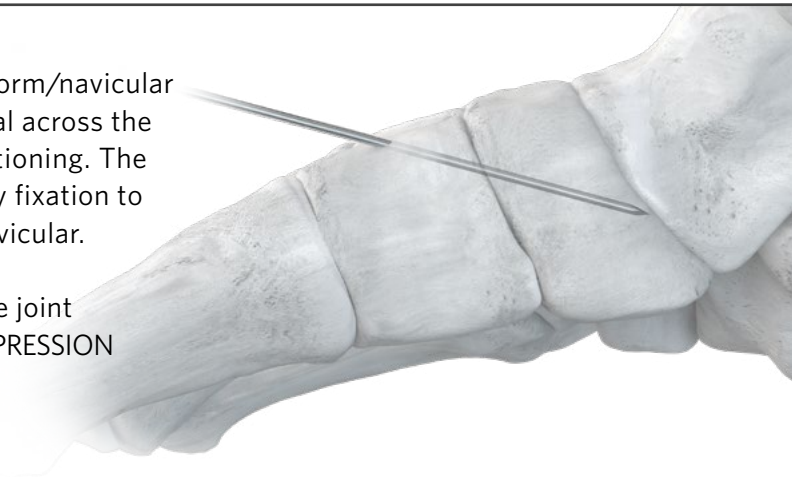

TEMPLATE SELECTION

Select the template for the operative side that best fits the patient, as it is a 1:1 match to plate size. Align the template such that the laser marking falls along and is parallel to the NC joint. As template/plate sizes increase from Small to X-Large, the plate length grows. Plate length is patient dependent and per surgeon preference.

NOTE: If a prominent navicular tuberosity is present and the template for the NC Plate is not a proper anatomic fit to the navicular, remove a portion of the navicular tuberosity until adequate fit of the template to bone is achieved.

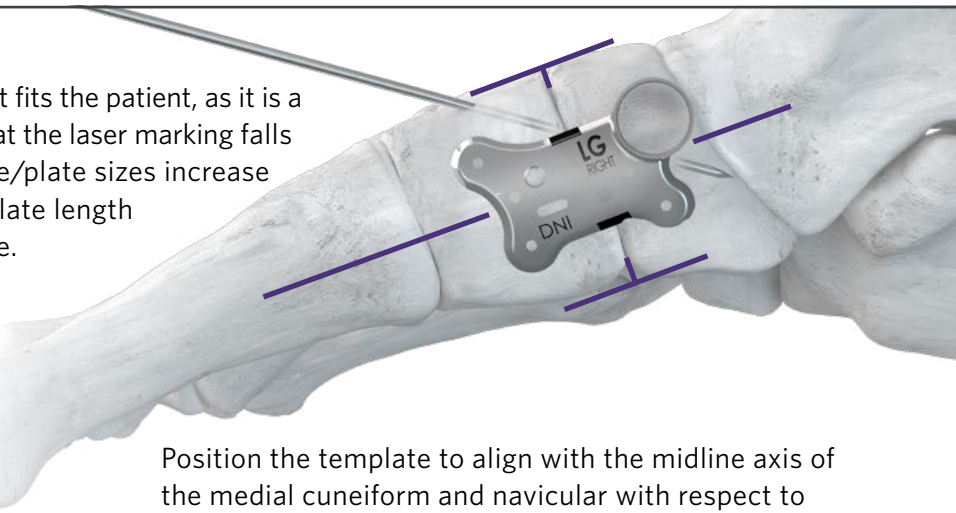

Position the template to align with the midline axis of the medial cuneiform and navicular with respect to dorsal/plantar positioning.

TEMPLATE FIXATION AND REAMING

TIP: To assist in retraction of the tibialis anterior tendon away from the dorsal distal hole on the template, the L-shaped end of a Senn retractor can be inserted around the tendon to assist in retraction of this structure throughout the procedure.

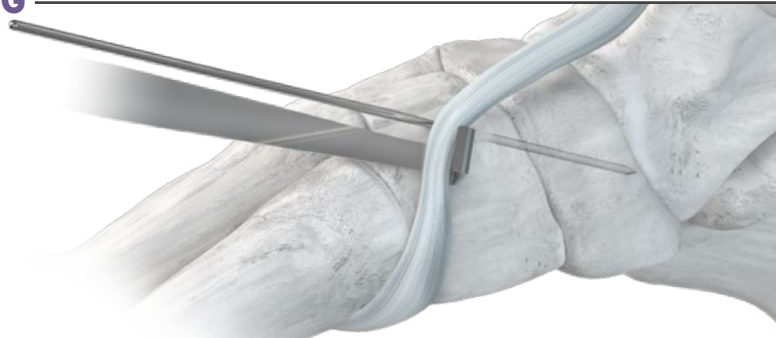

Place a threaded K-wire into the distal end of the slotted hole located centrally on the template. Place a threaded olive wire into one of the two proximal holes on the template into the navicular. Threaded K-wires and olive wires are provided and recommended to help prevent back-out of the template while reaming.

Distal placement of a K-wire into the slotted hole allows for the medial cuneiform to move proximally during compression. Confirm template position using fluoroscopy.



Once the template is secured, retrieve the reamer and attach the reamer to the handle.



The distance between solid lines (or the distance between dashed lines) represents the depth required for reaming the recessed portion of the plate.

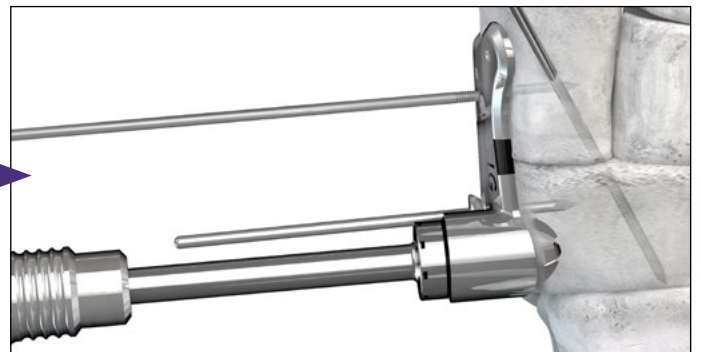
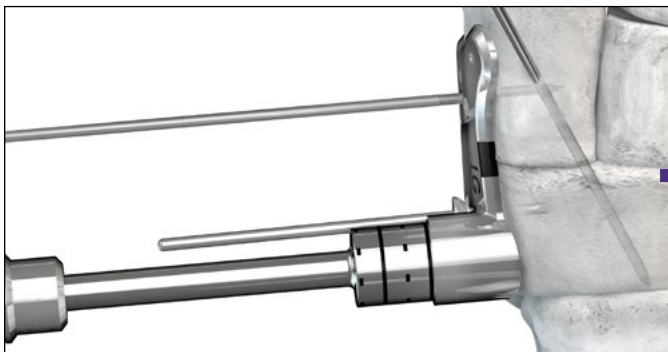

Insert the reamer into the counter bore until it touches bone.

- Note if a solid or dashed line is closest to the top of the counter bore.
- In the instance above, a solid line is closest to the top of the counter bore. Ream until the next solid line.

At this point, the hole depth is appropriate to receive the plate.

The olive wire is removed proximally and the template is slid off the distal K-wire, which remains in place.

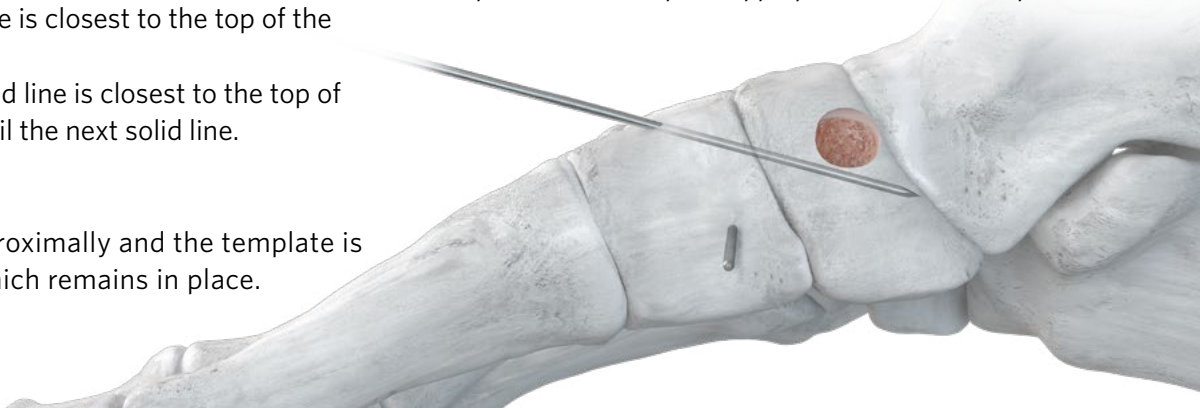

AT THIS TIME, PLATE AND SCREW PLACEMENT CAN BE ACHIEVED BY TWO METHODS:

1. COMPRESSION USING A PARTIALLY THREADED SCREW (refer to page 5)
2. EXTERNAL COMPRESSION USING A FULLY THREADED CROSS SCREW (refer to page 8)

SURGICAL TECHNIQUE GUIDE: NAVICULOCUNEIFORM ARTHRODESIS COMPRESSION USING A PARTIALLY THREADED SCREW

PERMANENT FIXATION

Attach the Precision Guide to the NC Plate prior to plate placement on bone.
Insert the set screw through the Precision Guide.

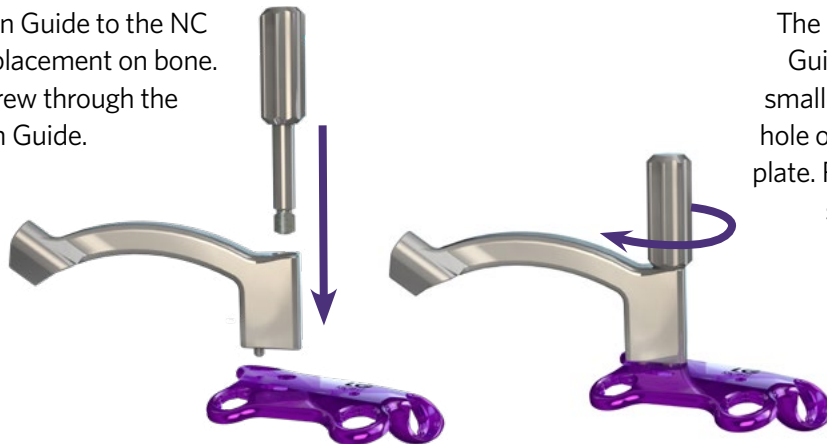

The alignment peg on the Precision Guide should be inserted into the smaller hole adjacent to the threaded hole on the distal central aspect of the plate. Rotate the set screw clockwise to secure the Precision Guide to the NC Plate.

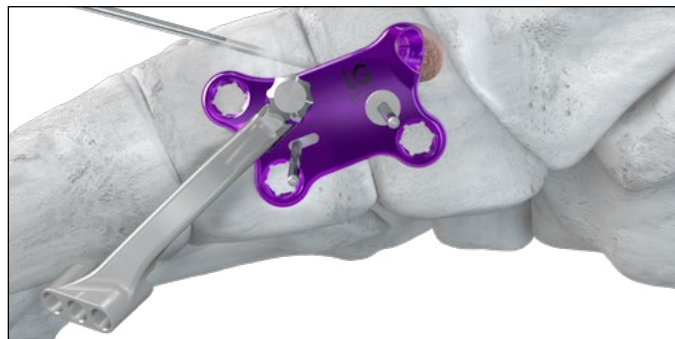
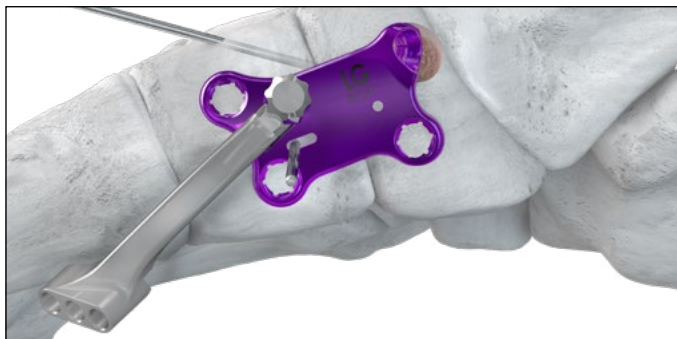

The selected plate and Precision Guide are then slid over the K-wire such that the K-wire is received in the slot of the plate and the recessed hole of the plate fits into the reamed hole. Place a threaded olive wire into the proximal wire hole in the plate.

NOTE: The more proximal hole will yield a more lateral position in the navicular and the more distal hole will yield a more medial position in the navicular. Screw trajectories will intersect at a point in the medial cuneiform.

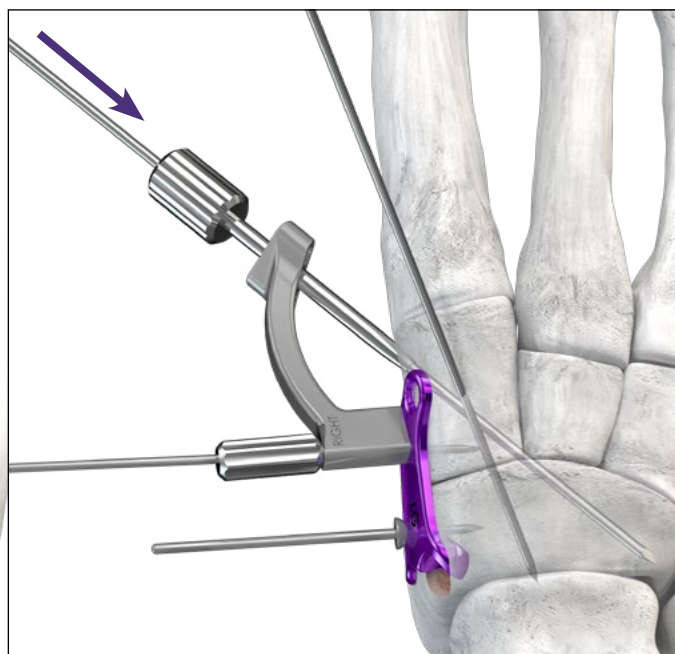
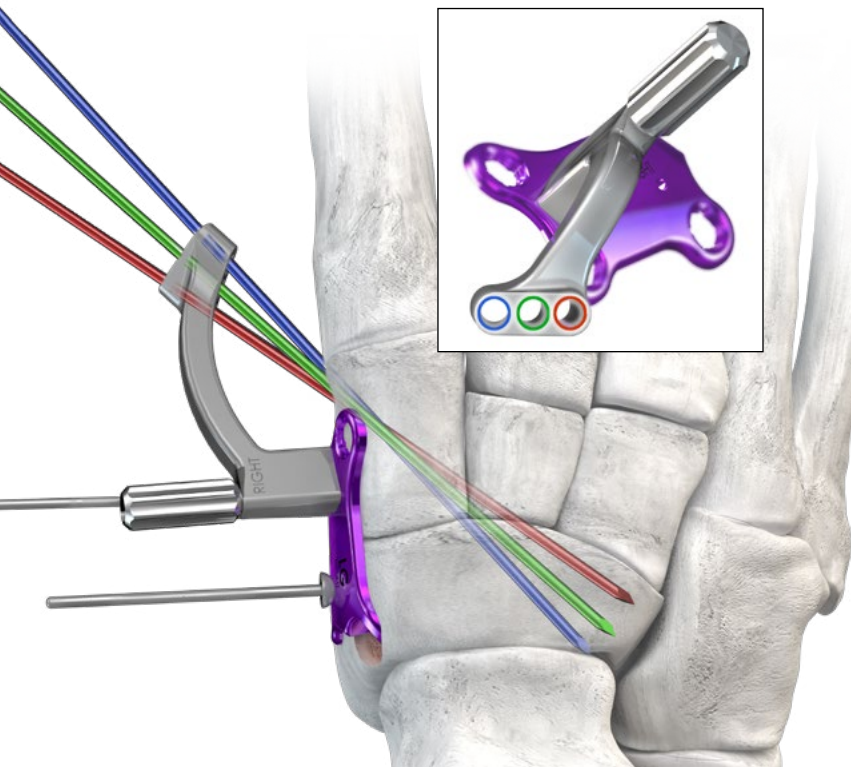

Insert the K-wire sleeve for the selected screw diameter into the Precision Guide to obtain the desired screw trajectory from the medial cuneiform to the navicular.

Insert the guide wire through the K-wire guide. Confirm guide wire placement and length using fluoroscopy.

SURGICAL TECHNIQUE GUIDE: NAVICULOCUNEIFORM ARTHRODESIS COMPRESSION USING A PARTIALLY THREADED SCREW

PERMANENT FIXATION

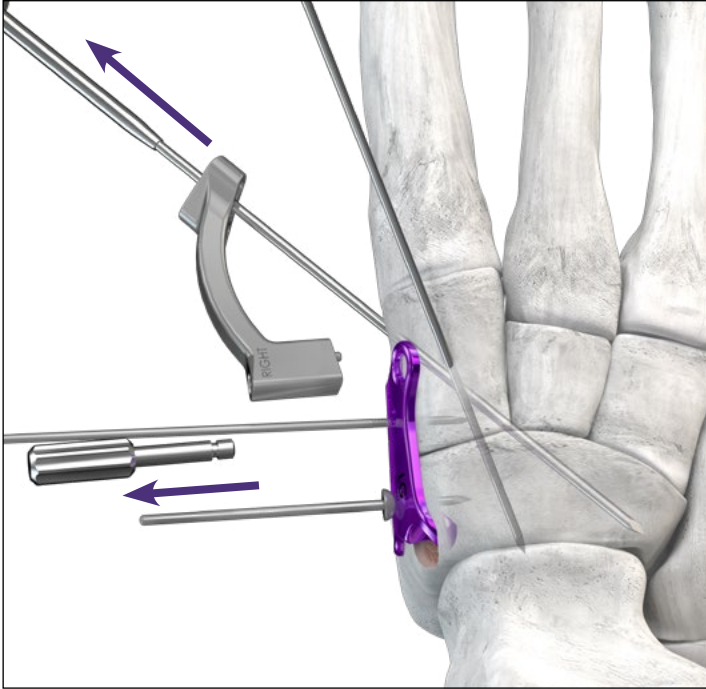

Remove the K-wire sleeve, set screw and Precision Guide from the plate.

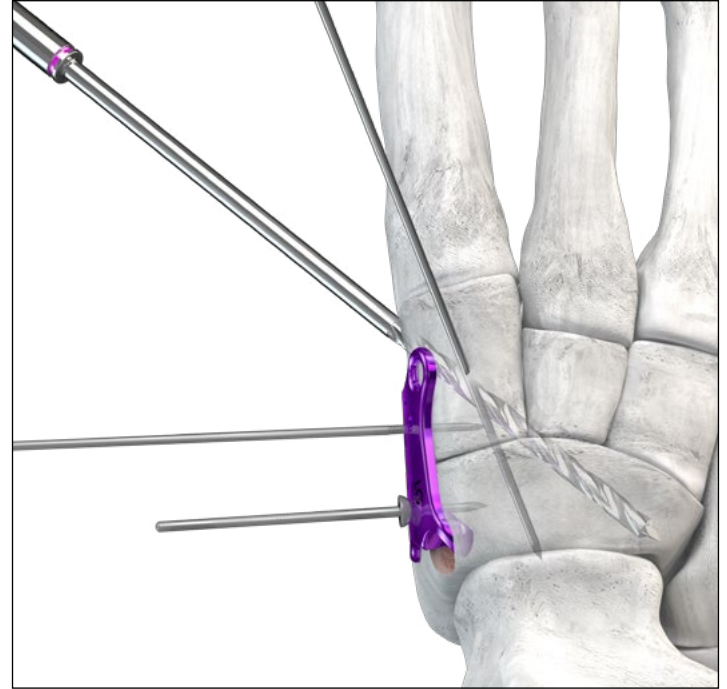

Measure guide wire length using a depth gauge. If using a headed screw, countersink and then measure for screw length. If using a headless screw, countersink after measuring. Drill over the guide wire using the appropriate drill for the selected screw diameter.

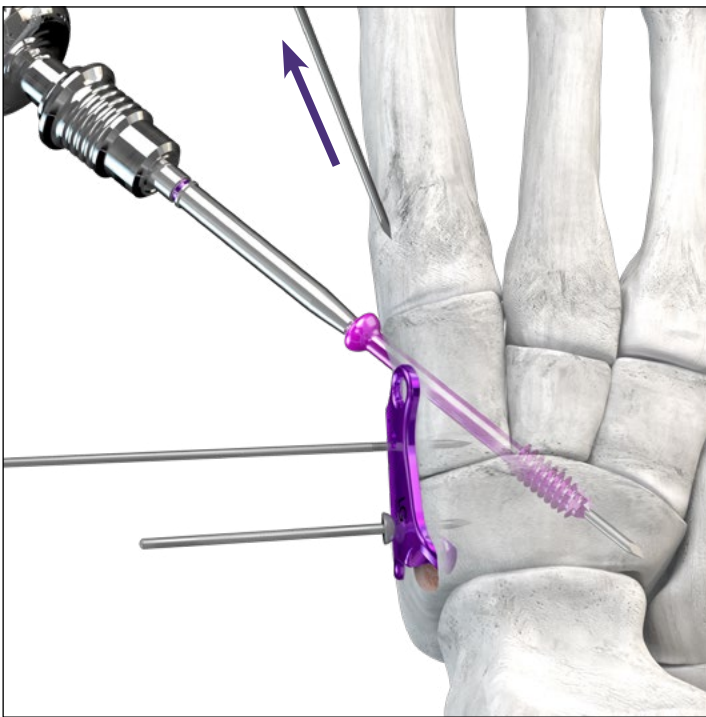

Insert the selected cannulated screw over the guide wire. After threads have crossed into the navicular and prior to the screw head contacting bone, remove the K-wire serving as temporary fixation.

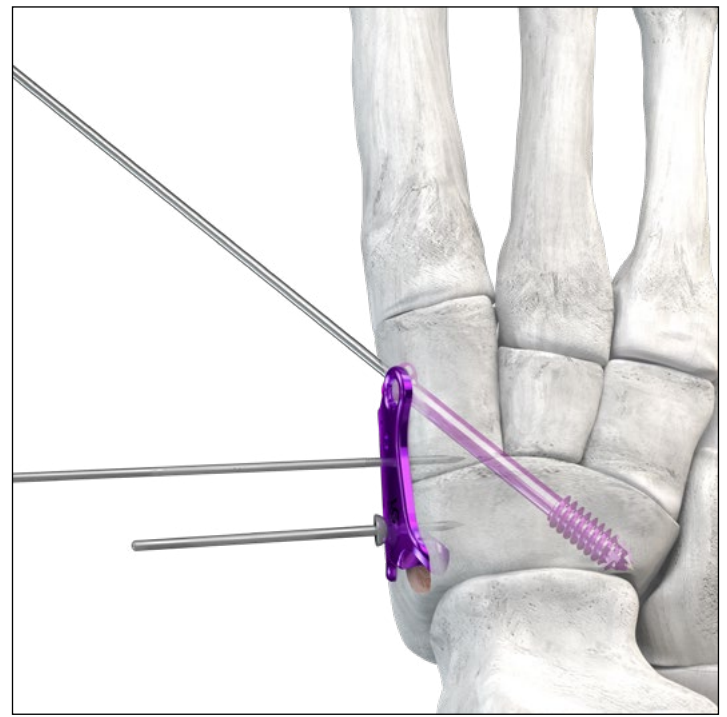

Complete screw insertion. Confirm screw length and position using fluoroscopy. Remove the guide wire.

SURGICAL TECHNIQUE GUIDE: NAVICULOCUNEIFORM ARTHRODESIS

COMPRESSION USING A PARTIALLY THREADED SCREW

PERMANENT FIXATION

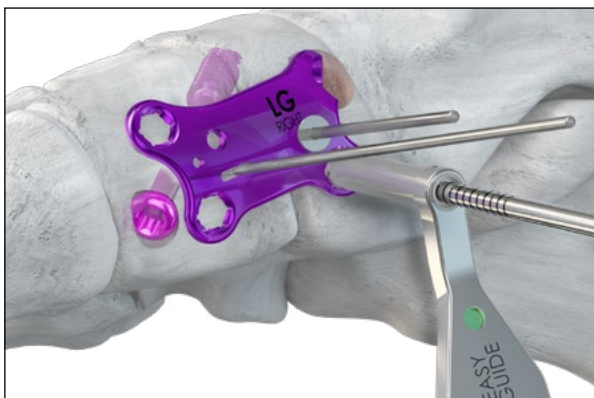

Using a drill guide, drill the plantar proximal hole in the navicular using the drill corresponding to desired screw diameter. Measure screw length using a depth gauge.



Insert the selected screw into the plantar proximal hole in the plate.



Using the EZ-Guide side of the standard drill guide, insert the drill guide in the dorsal proximal hole such that the protrusions on the drill guide mate with the scallops in the screw hole. If mating does not occur, rongeur a small amount off the proximal navicular along the path of the drill guide. Drill through the drill guide.

NOTE: The trajectory of the recessed hole has been designed to aim for the intermediate cuneiform. If off-axis drilling is performed, there is potential to miss the intermediate cuneiform and/or collide with the crossing screw.

It is important to use a drill guide during this step to get the appropriate trajectory for the plate screw to cross into the intermediate cuneiform.

Insert the selected plate screw into the proximal dorsal hole.

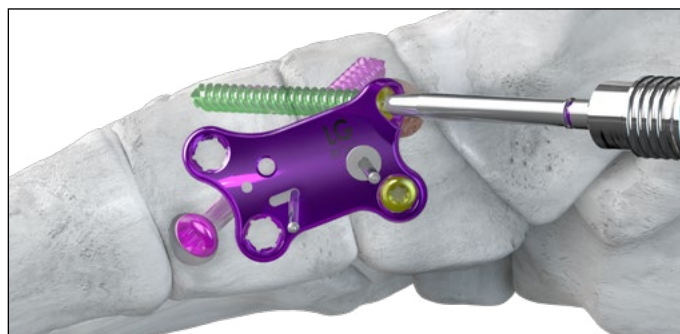

Using the technique described above for inserting plate screws, insert plate screws into the dorsal distal and plantar distal plate holes.

Confirm screw length and placement using fluoroscopy.

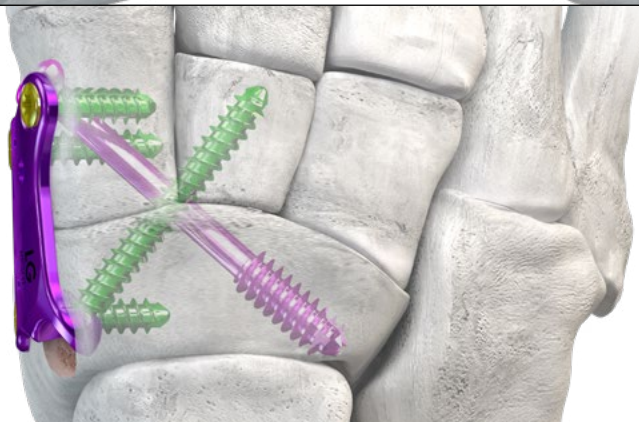

CLOSURE

Proceed to incision closure or concomitant procedures at this time.

TEMPORARY FIXATION AND REAMING

If a surgeon wishes to use external compression such as a pin compressor, it can be performed prior to or after template placement.



Secure the template by placing an olive wire into the navicular and a K-wire into the distal end of the slot in the medial cuneiform. Prior to compression, remove any K-wires across the medial cuneiform/navicular joint.

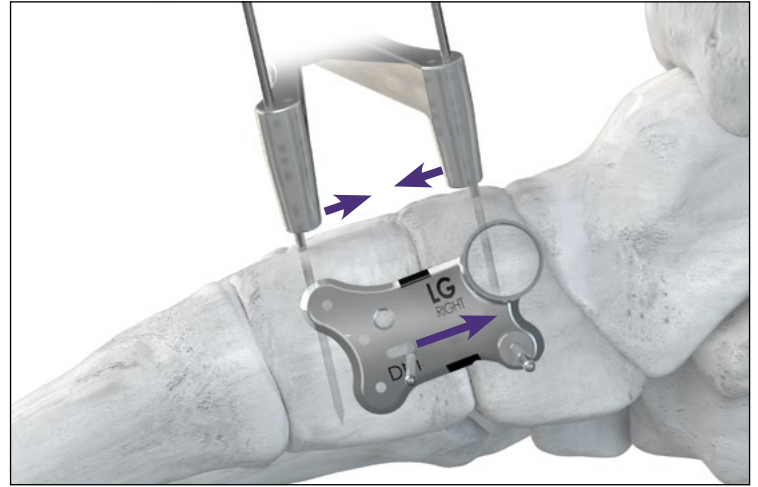

Compress using the pin compressor.

TIP: If using external compression, it is advised to use a fully threaded crossing screw either prior to or after placement of plate screws.

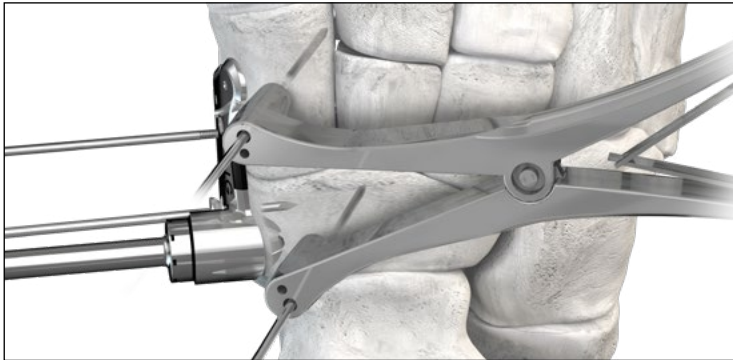

Use the reamer in the counter bore as described on page 4 of the surgical technique guide.

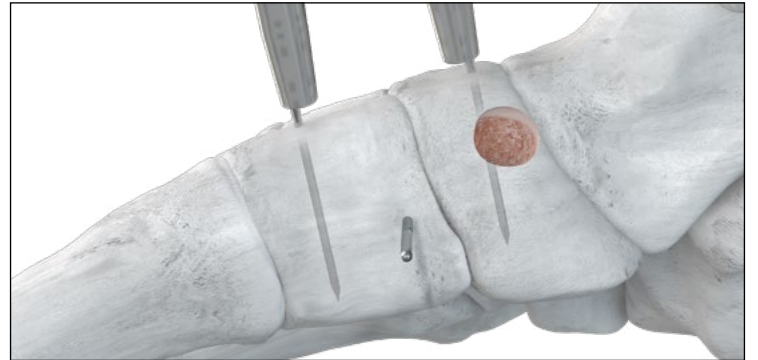

Remove the olive wire in the template and slide the template off of the K-wire in the medial cuneiform.

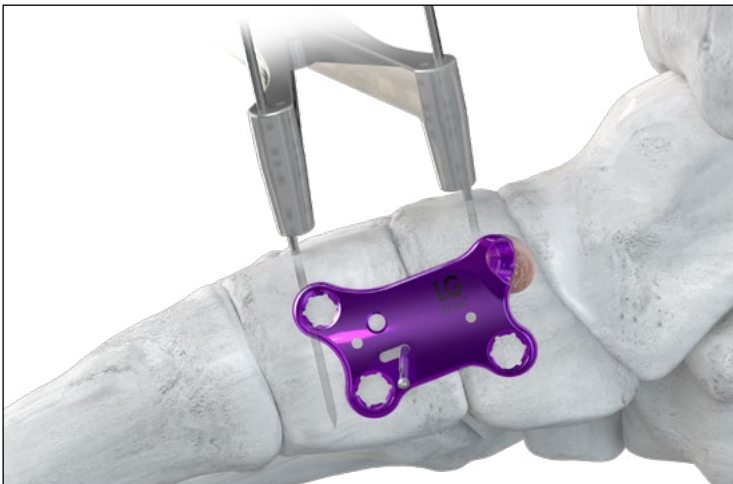

The selected plate size is then slid over the K-wire such that the K-wire is received in the slot of the plate and the recessed hole of the plate fits into the reamed hole

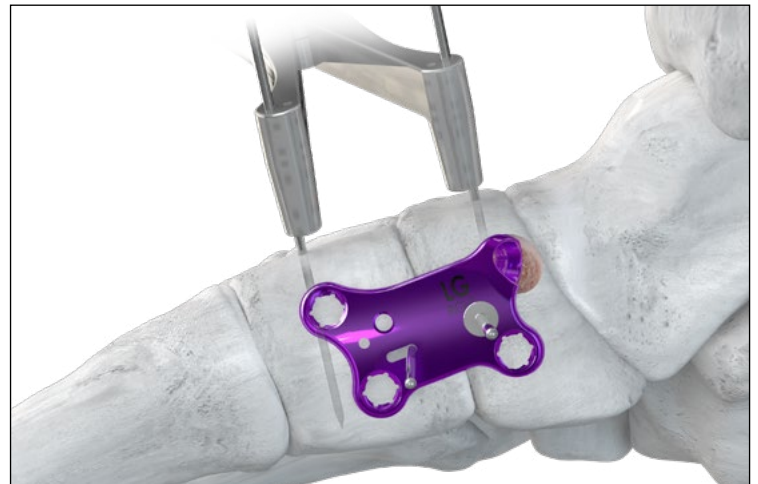

Place a threaded olive wire into the proximal hole in the plate.

PERMANENT FIXATION

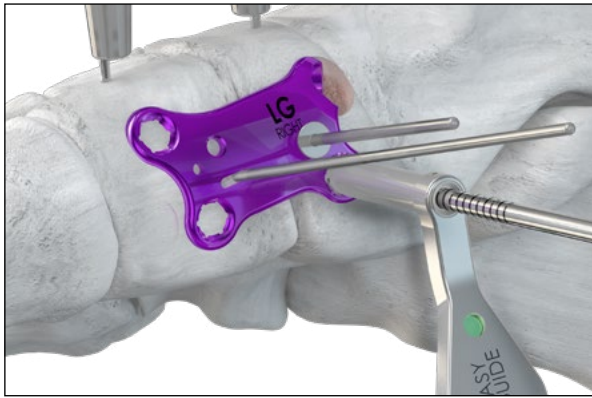

Using a drill guide, drill the plantar proximal hole in the navicular using the drill corresponding to desired screw diameter. Measure screw length using a depth gauge.

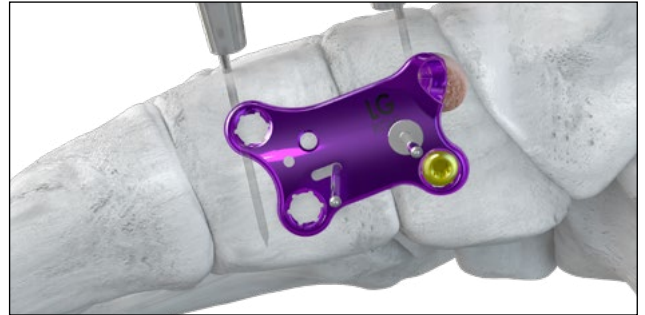

Insert the selected screw into the plantar proximal hole in the plate.

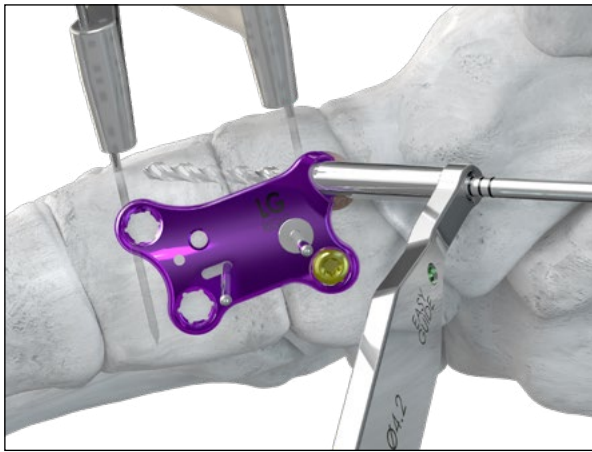

Using the EZ-Guide side of the standard drill guide, insert the drill guide in the dorsal proximal hole such that the protrusions on the drill guide mate with the scallops in the screw hole. If mating does not occur, rongeur a small amount off the proximal navicular along the path of the drill guide. Drill through the drill guide.

NOTE: The trajectory of the recessed hole has been designed to aim for the intermediate cuneiform. If off-axis drilling is performed, there is potential to miss the intermediate cuneiform and/or collide with the crossing screw.

It is important to use a drill guide during this step to get the appropriate trajectory for the plate screw to cross into the intermediate cuneiform.

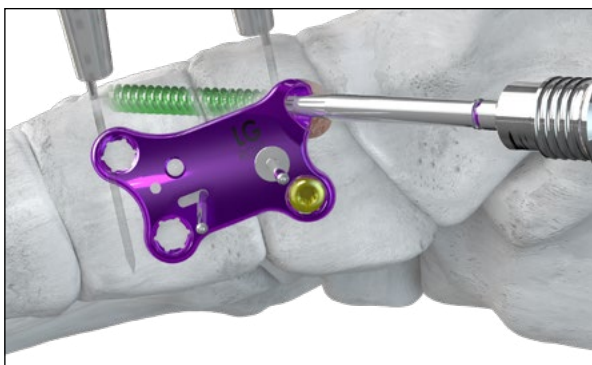

Insert the selected plate screw into the proximal dorsal hole.

Using the technique described above for inserting plate screws, insert plate screws into the dorsal distal and plantar distal plate holes.

Remove the olive wire and K-wire in the plate.
Remove the external compression device after all four plate screws have been placed.

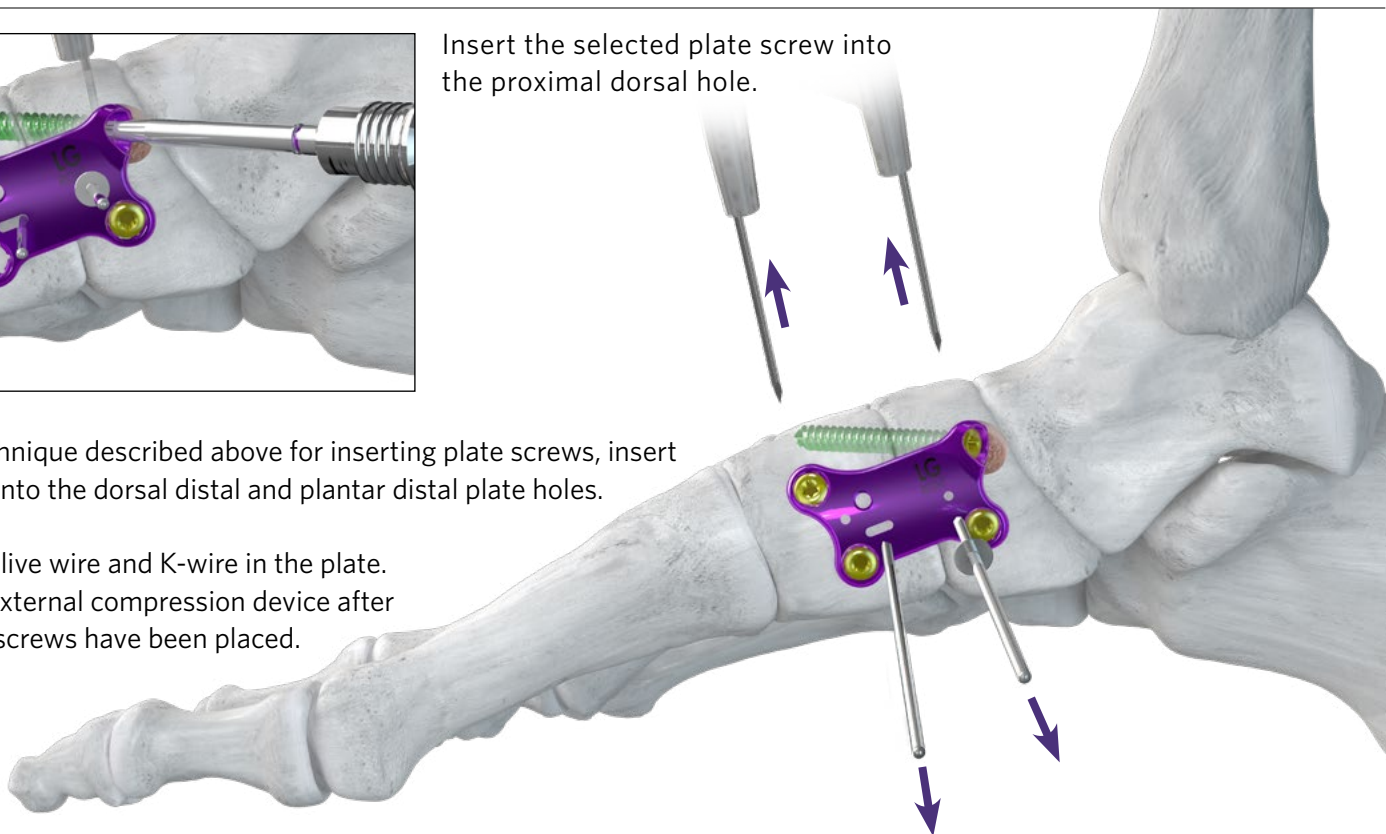

PERMANENT FIXATION

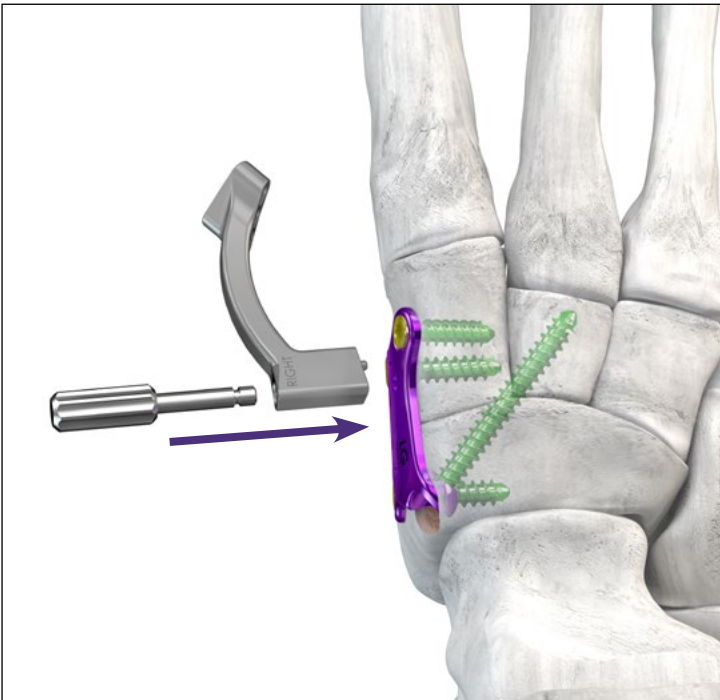

Attach the Precision Guide to the plate by inserting the set screw through the Precision Guide.

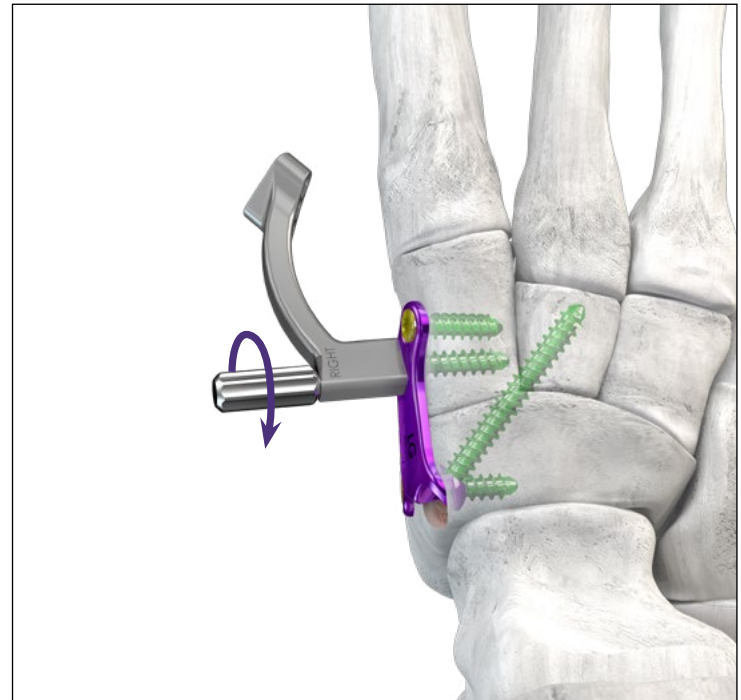

The alignment peg on the Precision Guide should be inserted into the smaller hole adjacent to the threaded hole on the distal central aspect of the plate. Rotate the set screw clockwise to secure the Precision Guide to the NC Plate.

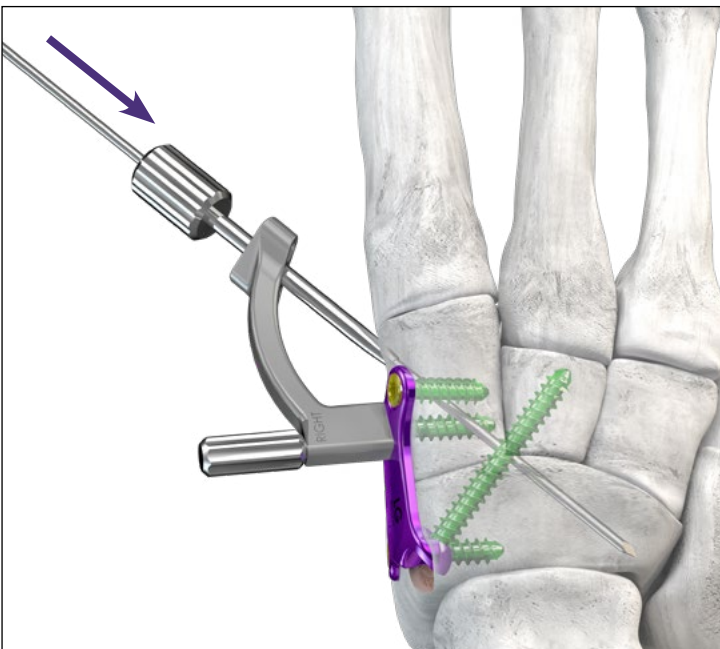

Insert the K-wire sleeve for the selected screw diameter into the Precision Guide to obtain the desired screw trajectory from the medial cuneiform to the navicular. Refer to page 5 of this technique on positioning this guide wire. Insert the guide wire through the K-wire sleeve.

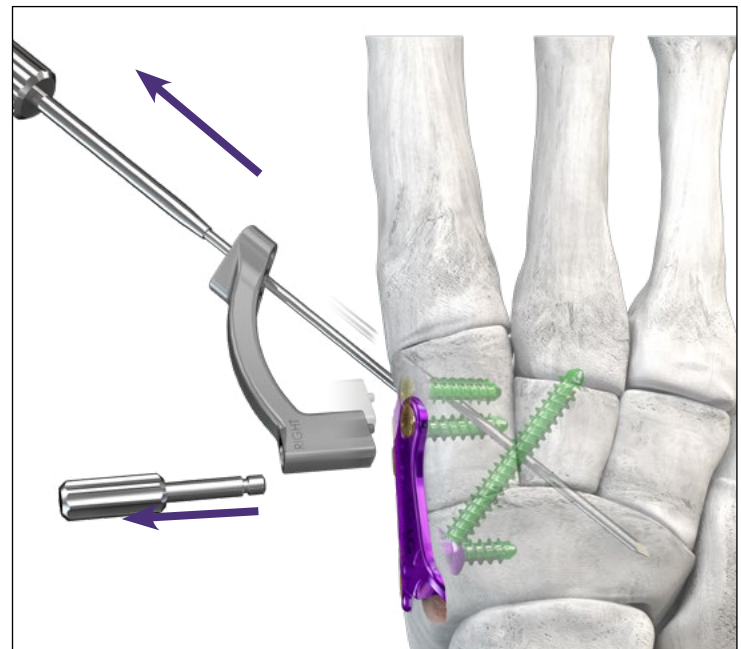

Remove the K-wire sleeve, set screw and Precision Guide from the plate.

PERMANENT FIXATION

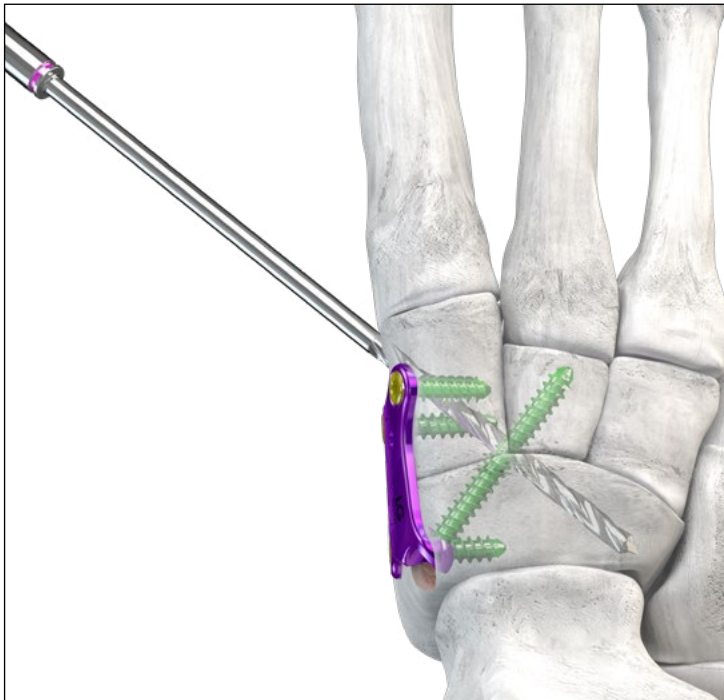

Measure guide wire length using a depth gauge. If using a headed screw, countersink and then measure for screw length. If using a headless screw, countersink after measuring.

Drill over the guide wire using the appropriate drill for the selected screw diameter.

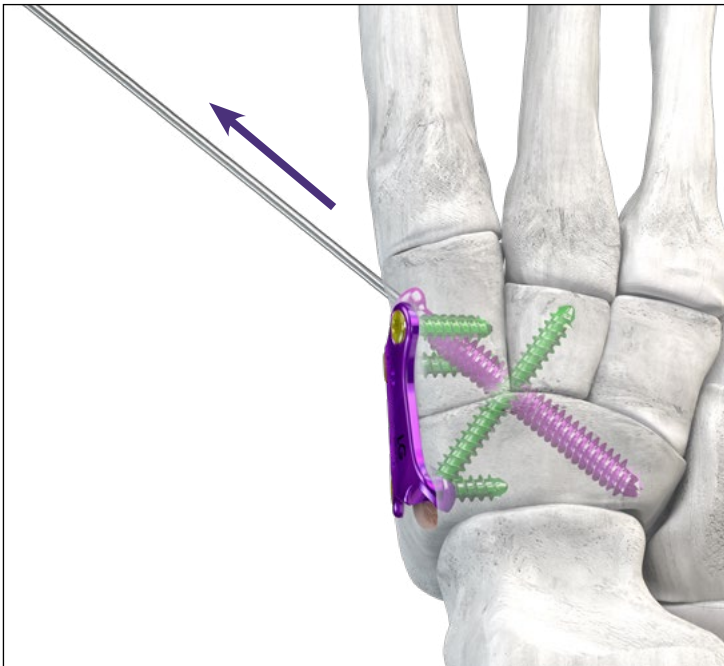

Complete screw insertion. Confirm screw length and position using fluoroscopy. Remove the guide wire.

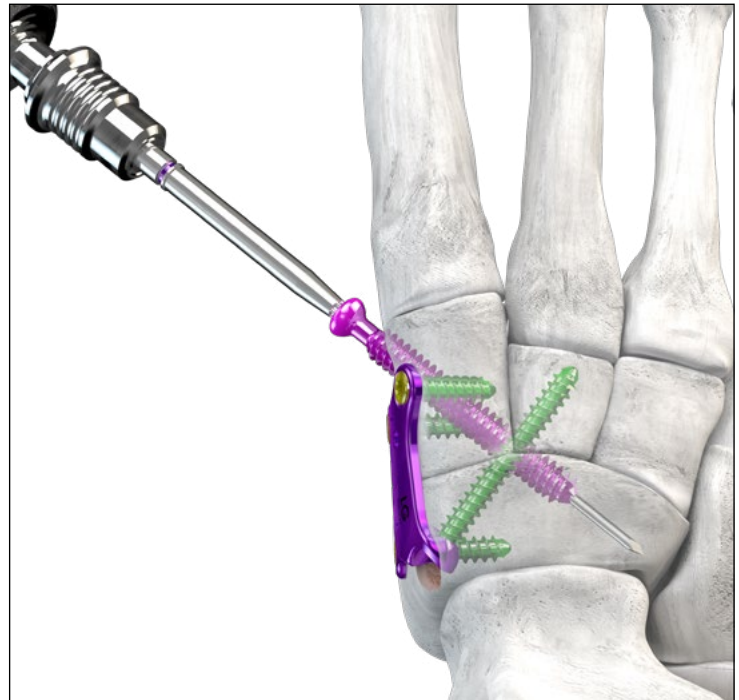

Insert the selected screw over the guide wire.

NOTE: When using external compression prior to cross screw placement, a fully threaded screw is recommended to maintain the compression that was achieved using the external compressor.



CLOSURE

Proceed to incision closure or concomitant procedures at this time.

SURGICAL TECHNIQUE GUIDE:

GORILLA® NC PLATING SYSTEM

Gorilla® NC Plate Caddy

The Gorilla® NC Plate Caddy contains the left and right NC Plate and template options. The system specific reamer, Precision™ Guide, set screws, K-wire sleeves and 1.4 mm K-wires are also included in this caddy.

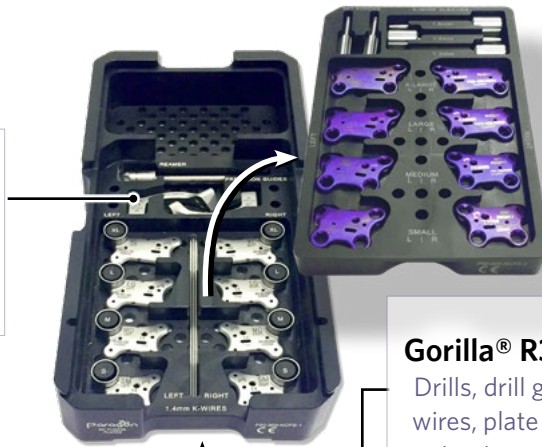

Gorilla® R3CON Instrument Caddy

Drills, drill guides, centering guides, olive wires, plate benders, drivers, K-wires and a depth gauge are located in the Gorilla® R3CON Instrument Caddy.

Additional Gorilla® Caddies

The Gorilla® Case has room for additional Gorilla® Plate Caddies or PRESERVE® Allograft caddies that may be needed for additional procedures performed in addition to an NC Arthrodesis.

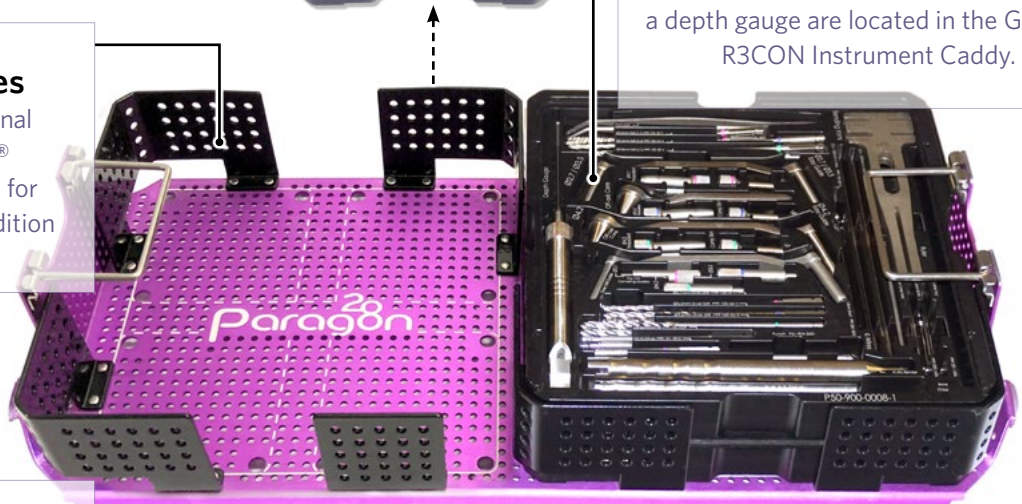

Mini-Monster® Screw Caddy

The Gorilla® Case can accommodate one Mini-Monster® Screw Caddy if a 3.5 mm or 4.0 mm cannulated screw is used with an NC Plate.



Gorilla® Case

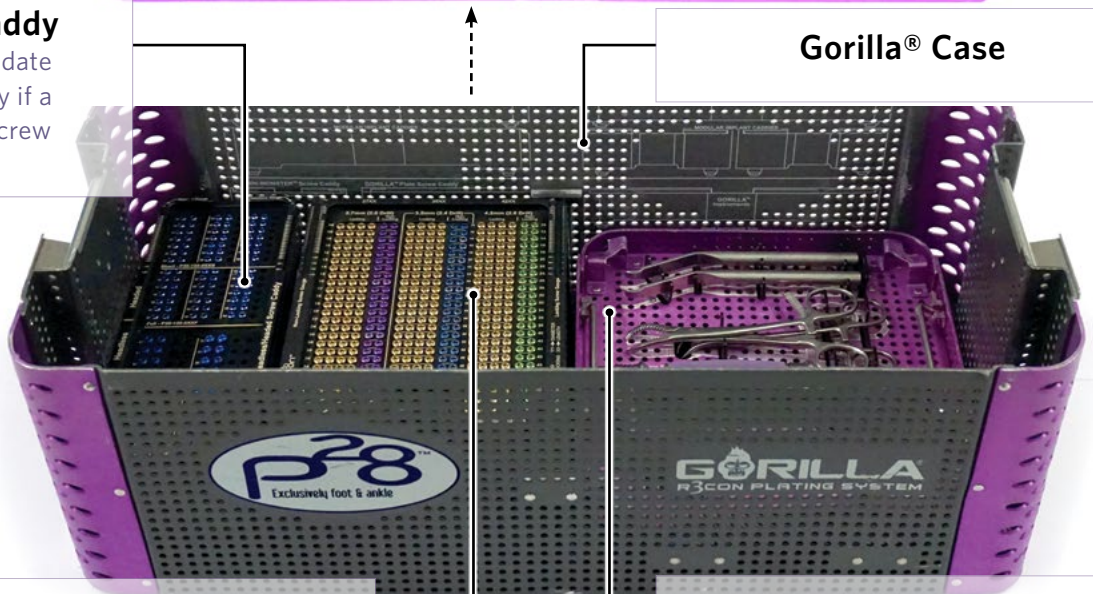

Gorilla® Screw Optionality

The Gorilla® screw length options for both locking and non-locking screws are as follows:

2.7 mm	1 mm increments, 8-20 mm	
2.7 mm	2 mm increments, 22-40 mm	
3.5 mm	2 mm increments, 10-50 mm	
4.2 mm	2 mm increments, 10-50 mm	
4.2 mm	5 mm increments, 55-70 mm	

Gorilla® R3CON Instruments

The Caspar Compression/Distraction device, osteotomes, baby Bennet retractors, bone reduction clamps, periosteal elevator, cartilage removal device, pin distractor and handles are located at the bottom of the Gorilla® Case.

Refer to www.paragon28.com/ifus for the complete and most current instructions for use document.

INDICATIONS FOR USE: BABY GORILLA®/GORILLA® PLATING SYSTEM

The bone plates and bone screws of the Baby Gorilla®/Gorilla® Plating System are indicated for use in stabilization and fixation of fractures or osteotomies; intra and extra articular fractures, joint depression, and multi-fragmentary fractures; revision procedures, joint fusion and reconstruction of small bones of the toes, feet and ankles including the distal tibia, distal fibula, talus, and calcaneus. The system can be used in both adult and pediatric patients.

In addition, the non-locking, titanium alloy (Ti6Al4V ELI) screws and washers are indicated for use in bone reconstruction, osteotomy, arthrodesis, joint fusion, fracture repair and fracture fixation of the foot and ankle, including the tibia, fibula, tarsus, metatarsals, and phalanges, appropriate for the size of the device.

CONTRAINDICATIONS

Use of the Baby Gorilla®/Gorilla® Plating System is contraindicated in cases of inflammation, cases of active or suspected sepsis / infection and osteomyelitis; or in patients with certain metabolic diseases.

All applications that are not defined by the indications are contraindicated. In addition, surgical success can be adversely affected by:

- Acute or chronic infections, local or systemic
- Vascular, muscular or neurological pathologies that compromise the concerned extremity
- All concomitant pathologies that could affect the function of the implant
- Osteopathies with reduced bone substance that could affect the function of the implant
- Any mental or neuromuscular disorder that could result in an unacceptable risk of failure at the time of fixation or complications in post-operative treatment
- Known or suspected sensitivity to metal
- Corpulence; an overweight or corpulent patient can strain the implant to such a degree that stabilization or implant failure can occur
- Whenever the use of the implant comes into conflict with the anatomical structures of physiological status

Other medical or surgical pre-conditions that could compromise the potentially beneficial procedure, such as:

- The presence of tumors
- Congenital abnormalities
- Immunosuppressive pathologies
- Increased sedimentation rates that cannot be explained by other pathologies
- Increased leukocyte (WBC) count
- Pronounced left shift in the differential leukocyte count

POTENTIAL COMPLICATIONS AND ADVERSE REACTIONS

In any surgical procedure, the potential for complications and adverse reactions exist. The risks and complications with these implants include:

- Loosening, deformation or fracture of the implant
- Acute post-operative wound infections and late infections with possible sepsis
- Migration, subluxation of the implant with resulting reduction in range of movement
- Fractures resulting from unilateral joint loading
- Thrombosis and embolism
- Wound hematoma and delayed wound healing
- Temporary and protracted functional neurological perturbation
- Tissue reactions as the result of allergy or foreign body reaction to dislodged particles
- Corrosion with localized tissue reaction and pain
- Pain, a feeling of malaise or abnormal sensations due to the implant used
- Bone loss due to stress shielding

All possible complications listed here are not typical of Paragon 28®, Inc. products but are in principle observed with any implant. Promptly inform Paragon 28®, Inc. as soon as complications occur in connection with the implants or surgical instruments used. In the event of premature failure of an implant in which a causal relationship with its geometry, surface quality or mechanical stability is suspected, please provide Paragon 28®, Inc. with the explant(s) in a cleaned, disinfected and sterile condition. Paragon 28®, Inc. cannot accept any other returns of used implants. The surgeon is held liable for complications associated with inadequate asepsis, inadequate preparation of the osseous implant bed in the case of implants, incorrect indication or surgical technique or incorrect patient information and consequent incorrect patient behavior.

WARNINGS AND PRECAUTIONS

- Re-operation to remove or replace implants may be required at any time due to medical reasons or device failure. If corrective action is not taken, complications may occur.
- Use of an undersized plate or screw in areas of high functional stresses may lead to implant fracture and failure.
- Plates and screws, wires, or other appliances of dissimilar metals should not be used together in or near the implant site.
- The implants and guide wires are intended for single use only.
- Instruments, guide wires and screws are to be treated as sharps.
- Patient risk as a result of the Baby Gorilla®/Gorilla® Plating System in the MR environment has been minimized.
- **Do not use other manufacturer's instruments or implants in conjunction with the Baby Gorilla®/Gorilla® Plating System.**
- **Do not implant the instruments.**

Refer to www.paragon28.com/ifus for the complete and most current instructions for use document.

MRI SAFETY INFORMATION



A person with the Paragon 28® Baby Gorilla®/Gorilla® Plating System may be safely scanned under the following conditions. Failure to follow these conditions may result in injury.

Name/Identification of Device	Paragon 28® Baby Gorilla®/Gorilla® Plating System
Nominal value(s) of Static Magnetic Field [T]	1.5 T or 3 T
Maximum Spatial Field Gradient [T/m and gauss/cm]	30 T/m (3000 gauss/cm)
RF Excitation	Circularly Polarized (CP)
RF Transmit Coil Type	Whole body transmit coil, Head RF transmit-receive coil
Operating Mode	Normal Operating Mode
Maximum Whole Body SAW [W/kg]	2.0 W/kg (Normal Operating Mode)
Limits on Scan Duration	2.0 W/kg whole body average SAR for 60 minutes of continuous RF (a sequence or back to back series/scan without breaks)
MR Image Artifact	The presence of this implant may produce an image artifact.

Refer to www.paragon28.com/ifus for the complete and most current instructions for use document.

INDICATIONS FOR USE: MONSTER® SCREW SYSTEM

The Monster® Screw System is indicated for use in bone reconstruction, osteotomy, arthrodesis, joint fusion, ligament fixation, fracture repair and fracture fixation of the foot and ankle, including the tibia, fibula, tarsus, metatarsals, and phalanges and the joints and ligaments coupling said bones, appropriate for the size of the device.

CONTRAINDICATIONS

Use of the Monster® Screw System is contraindicated in cases of inflammation, cases of active or suspected sepsis / infection and osteomyelitis; or in patients with certain metabolic diseases.

All applications that are not defined by the indications are contraindicated. In addition, surgical success can be adversely affected by:

- Acute or chronic infections, local or systemic
- Vascular, muscular or neurological pathologies that compromise the concerned extremity
- All concomitant pathologies that could affect the function of the implant
- Osteopathies with reduced bone substance that could affect the function of the implant
- Any mental or neuromuscular disorder that could result in an unacceptable risk of failure at the time of fixation or complications in post-operative treatment
- Known or suspected sensitivity to metal
- Corpulence; an overweight or corpulent patient can strain the implant to such a degree that stabilization or implant failure can occur
- Whenever the use of the implant comes into conflict with the anatomical structures of physiological status

Other medical or surgical pre-conditions that could compromise the potentially beneficial procedure, such as:

- The presence of tumors
- Congenital abnormalities
- Immunosuppressive pathologies
- Increased sedimentation rates that cannot be explained by other pathologies
- Increased leukocyte (WBC) count
- Pronounced left shift in the differential leukocyte count

POTENTIAL COMPLICATIONS AND ADVERSE REACTIONS

In any surgical procedure, the potential for complications and adverse reactions exist. The risks and complications with these implants include:

- Loosening, deformation or fracture of the implant
- Acute post-operative wound infections and late infections with possible sepsis
- Migration, subluxation of the implant with resulting reduction in range of movement
- Fractures resulting from unilateral joint loading
- Thrombosis and embolism
- Wound hematoma and delayed wound healing
- Temporary and protracted functional neurological perturbation
- Tissue reactions as the result of allergy or foreign body reaction to dislodged particles

- Corrosion with localized tissue reaction and pain
- Pain, a feeling of malaise or abnormal sensations due to the implant used
- Bone loss due to stress shielding

All possible complications listed here are not typical of Paragon 28®, Inc. products but are in principle observed with any implant. Promptly inform Paragon 28® as soon as complications occur in connection with the implants or surgical instruments used. In the event of premature failure of an implant in which a causal relationship with its geometry, surface quality or mechanical stability is suspected, please provide Paragon 28® with the explant(s) in a cleaned, disinfected and sterile condition. Paragon 28® cannot accept any other returns of used implants. The surgeon is held liable for complications associated with inadequate asepsis, inadequate preparation of the osseous implant bed in the case of implants, incorrect indication or surgical technique or incorrect patient information and consequent incorrect patient behavior.

WARNINGS AND PRECAUTIONS

- Re-operation to remove or replace implants may be required at any time due to medical reasons or device failure. If corrective action is not taken, complications may occur.
- Use of an undersized screw in areas of high functional stresses may lead to implant fracture and failure.
- Plates and screws, wires, or other appliances of dissimilar metals should not be used together in or near the implant site.
- The implants and guide wires are intended for single use only. Re-use may cause product failure and could lead to disease transmission.
- Instruments, guide wires and screws are to be treated as sharps.
- **Do not use other manufacturer's instruments or implants in conjunction with the Monster® Screw System.**

Refer to www.paragon28.com/ifus for the complete and most current instructions for use document.

MRI SAFETY INFORMATION



A person with the Paragon 28® Monster® Screw System may be safely scanned under the following conditions. Failure to follow these conditions may result in injury.

Name/Identification of Device	Paragon 28® Monster® Screw System
Nominal value(s) of Static Magnetic Field [T]	1.5 T or 3 T
Maximum Spatial Field Gradient [T/m and gauss/cm]	30 T/m (3000 gauss/cm)
RF Excitation	Circularly Polarized (CP)
RF Transmit Coil Type	Whole body transmit coil, Head RF transmit-receive coil
Maximum Whole Body SAW [W/kg]	2.0 W/kg (Normal Operating Mode)
Limits on Scan Duration	All anatomic regions can be safely scanned under the following conditions: 2.0 W/kg whole body average SAR for 5 minutes of continuous RF (a sequence or back to back series/scan without breaks) with a 20 minute cooling period between scans for an hour long scanning session
	Scanning of the knees and all anatomy superior to the knees can be safely scanned under the following conditions: 2.0 W/kg whole body average SAR for 60 minutes of continuous RF (a sequence or back to back series/scan without breaks)
MR Image Artifact	The presence of this implant may produce an image artifact of 20mm
If information about a specific parameter is not included, there are no conditions associated with that parameter.	



NC Plating System

PATENTED, DESIGNED & EXCLUSIVELY DISTRIBUTED BY

Exclusively foot & ankle
Paragon²⁸[®]

P51-STG-3007 Rev B [2024-05-15]

™Trademarks and ®Registered Marks of Paragon 28®, Inc.

© Copyright 2024 Paragon 28®, Inc. All rights reserved.

Patents: www.paragon28.com/patents

Paragon 28, Inc. 
14445 Grasslands Dr.
Englewood, CO 80112
(855) 786-2828

Australian Sponsor
Actis Medical Pty Ltd.
Ground Floor, U1/18 Dequetteville Terrace
Kent Town, SA 5067
Australia

DISCLAIMER

The purpose of the NC Arthrodesis Surgical Technique Guide is to demonstrate the use of the NC Plate in the Gorilla® R3CON Plating System. Although various methods can be employed for this procedure, the fixation options demonstrated were chosen for simplicity of explanation and demonstration of the unique features of our device. Federal law (U.S.A.) restricts this device to sale and use by, or on order of, a physician.

www.Paragon28.com