

Exclusively foot & ankle **20**
Paragon[®]



SURGICAL TECHNIQUE GUIDE

Lateral Column Arthrodesis

**Gorilla[®] Lateral Column
Fusion Plating System**

GORILLA[®]
R3CON PLATING SYSTEM

SURGICAL TECHNIQUE GUIDE:

LATERAL COLUMN ARTHRODESIS

Acknowledgment:

Paragon 28® would like to thank Douglas Blackledge, DPM for his contribution to the development of the surgical technique guide.

PRODUCT DESCRIPTION

Paragon 28® developed the Gorilla® Lateral Column Fusion (LCF) Plating System to allow a surgeon to provide fixation across the 4th/5th tarsometatarsal joint and the calcaneocuboid joint. If the cuboid is subluxed plantarly while the 4th and 5th metatarsals are subluxed dorsally, breakdown of the tissue plantar to the cuboid can result in ulceration. The Gorilla® Lateral Column Plating System helps to address this problem by using a plate with locking screws across the 4th and 5th metatarsals and cuboid to help prevent the metatarsals from shifting dorsally, while using a 5.5 mm screw integrated into the plate to keep the cuboid from subluxing plantarly. This system is intended to address the difficulty of placing beaming screws into the 4th or 5th metatarsals, while providing a rigid construct to maintain proper cuboid alignment.

IMPLANT OFFERING

LCF Plates:



Left (Standard)



Left (Large)



Right (Standard)



Right (Large)

LCF Screw Offering:



Gorilla® Type II Anodized 5.5 mm Partially Threaded Beaming Plate Screws

- Offered in 80 - 120 mm, 5 mm increments
- Solid core, non-locking
- Consistent shank length to provide maximum amount of threads in the calcaneus



Gorilla® Type II Anodized 5.5 mm Fully Threaded Beaming Plate Screws

- Offered in 80 - 120 mm, 5 mm increments
- Solid core, non-locking

INSTRUMENTATION

LCF Plates:



Left Template (Standard)



Left Template (Large)



Right Template (Standard)



Right Template (Large)



Joint Preparation Paddle



Reamer

SURGICAL TECHNIQUE GUIDE:

LATERAL COLUMN ARTHRODESIS

INSTRUMENTATION

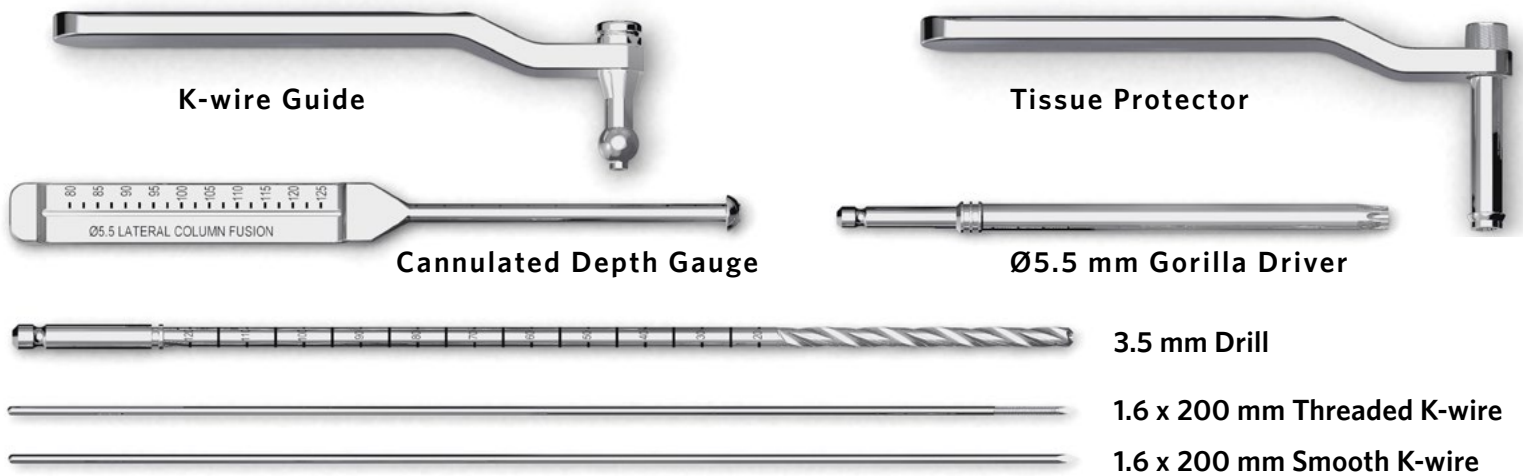

INCISION/EXPOSURE



Patient is positioned supine such that the foot is near the end of the table, or in lateral decubitus, based on surgeon preference. An incision is made over the calcaneocuboid joint proximally extending past the 4th/5th metatarsal-cuboid joint distally. Continue soft tissue dissection until the aforementioned joints are accessible.

JOINT PREPARATION/ TEMPORARY FIXATION



Remove the cartilage from the 4th/5th metatarsal-cuboid joint as well as the calcaneocuboid joint using a preferred technique.

NOTE: An attempt should be made to preserve the capsular ligaments of the proximal 4th/5th intermetatarsal joint to maintain stability of the 5th metatarsal during reaming and internal fixation.

Manipulate the calcaneus, cuboid and 4th/5th metatarsals to properly align the lateral column.



A first temporary fixation K-wire can be placed from the dorsal 5th metatarsal into the cuboid proximally. A second K-wire can be placed across the 5th, 4th and 3rd metatarsal. Temporary stabilization of the cuboid to the calcaneus is achieved by use of a 3rd K-wire. Variations in temporary fixation may exist due to bone quality and surgeon preference.

PLATE TEMPLATES

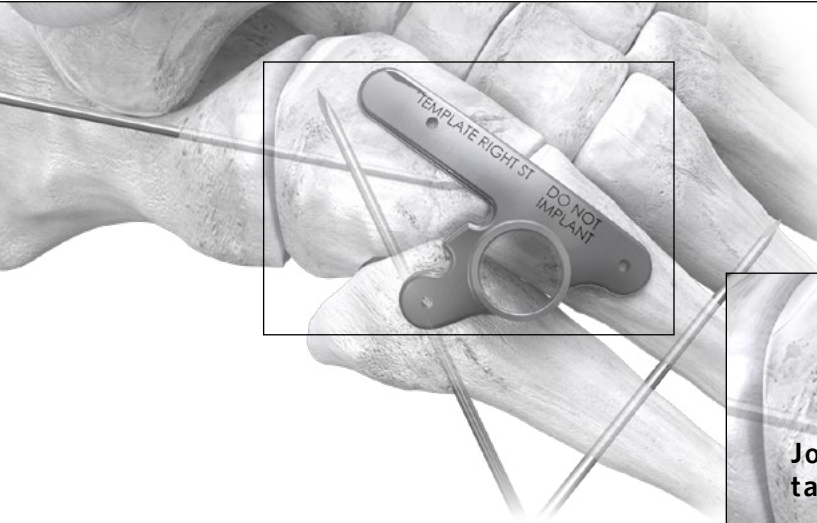

Position the Plate Template for the desired plate size over the cuboid and the 4th/5th metatarsals. Align the joint indicating tab (labeled below) of the Plate Template with the junction of the 4th/5th metatarsal-cuboid joint. Center the Plate Template over the 4th and 5th metatarsals as best as possible and confirm appropriate plate size.

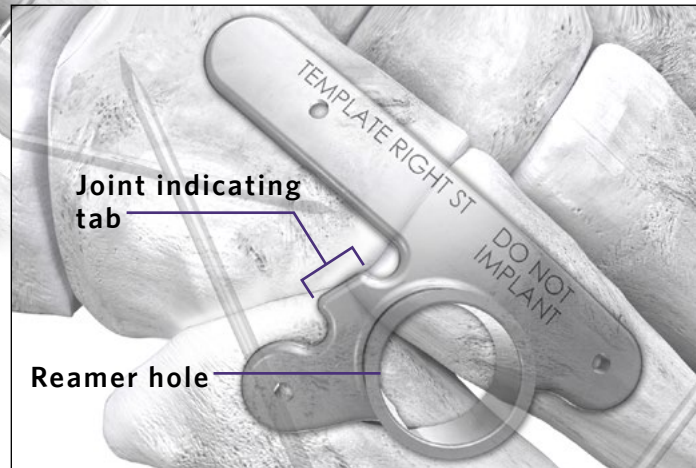

Locate the 4th/5th metatarsal joint by placing the Joint Preparation Paddle in the reamer hole (labeled above) in the Plate Template. Allow the Joint Preparation Paddle to align parallel to the metatarsals until it is able to be pushed into the 4th/5th metatarsal joint to center the Plate Template. This allows for equal reaming of the 4th and 5th metatarsals to limit weakening of a single bone.

Use of the Plate Template and Joint Preparation Paddle allow for the starting point of the 5.5 mm screw to be positioned 1 cm from the 4th/5th metatarsal-cuboid joint and centered for reaming between the 4th and 5th metatarsals.

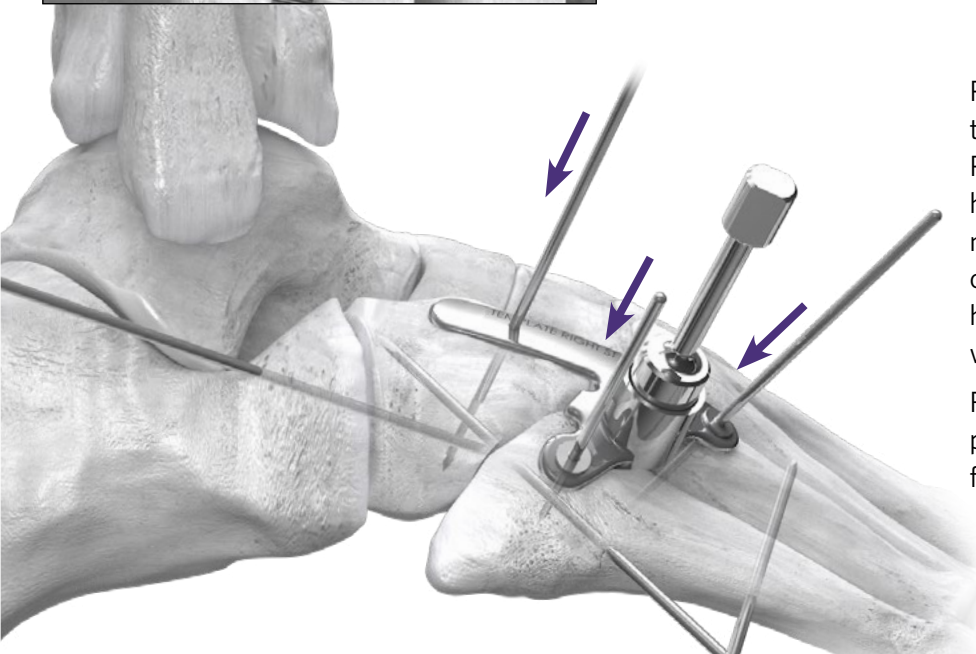

Place a threaded 1.6 mm K-wire into the cuboid through the proximal aspect of the Plate Template. Place two threaded olive wires into the distal holes of the Plate Template into the 4th and 5th metatarsals, respectively. Threaded K-wires and olive wires are provided and recommended to help prevent back-out of the Plate Template while reaming.

Remove the Joint Preparation Paddle. Confirm placement of the Plate Template under fluoroscopy.

SURGICAL TECHNIQUE GUIDE:

LATERAL COLUMN ARTHRODESIS

PLATE TEMPLATE



Once the Plate Template is secured, attach the reamer to the handle. Insert the reamer into the reamer hole in the Plate Template until it contacts bone. Note which line (solid or dashed) is closest to the top of the reaming hole. Ream until the next solid or dashed line, respectively, to ensure adequate depth of the reamed hole.

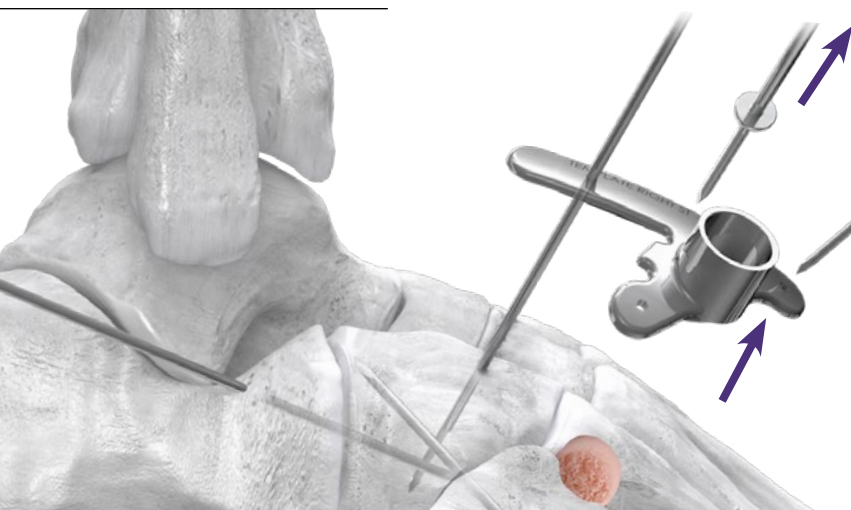
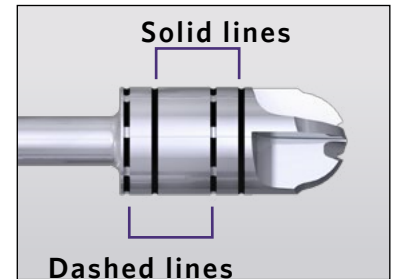

Remove the two olive wires distally, but retain the 1.6 mm K-wire in the cuboid for plate alignment. Slide the Plate Template off of the 1.6 mm K-wire.

PLATE FIXATION



The selected plate is then slid over the proximal K-wire such that the recessed hole of the plate fits in the reamed area of the 4th and 5th metatarsals.

NOTE: If the decision to move up or down a plate size at this point is made, the K-wire and reaming hole will still align to a different size plate.

Additional reaming may be necessary to seat the plate properly in the joint.



Place an olive wire in the 4th metatarsal plate hole. All plate holes (with the exception of the recessed hole) accept 2.7 mm, 3.5 mm or 4.2 mm locking or non-locking Gorilla screws. Place a drill guide into the 5th metatarsal plate hole. Drill a hole using the drill corresponding to the desired screw diameter. Measure screw length using a depth gauge.

SURGICAL TECHNIQUE GUIDE:

LATERAL COLUMN ARTHRODESIS

PLATE FIXATION



Insert the selected screw into the hole of the plate. Remove the olive wire from the 4th metatarsal.

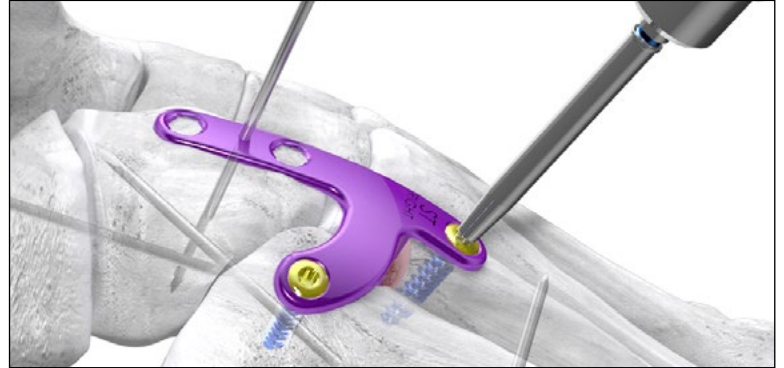

Using the technique described above for inserting plate screws, insert a plate screw into the 4th metatarsal plate hole.

CROSSING SCREW PLACEMENT

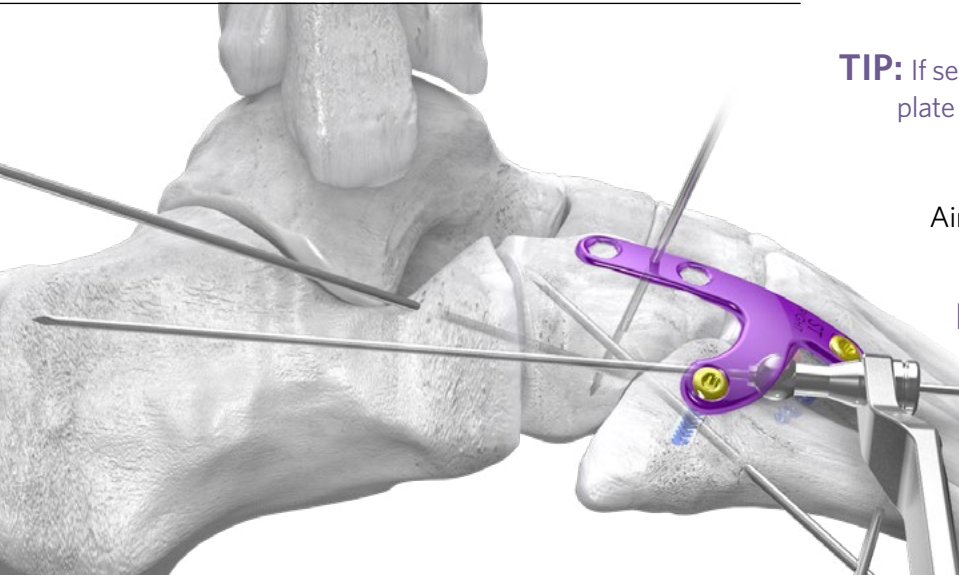

Mate the K-wire Guide in the recessed hole.

TIP: If seating of the K-wire Guide into the recessed hole of the plate is difficult, use a rongeur to remove a small amount of bone or soft tissue just distal to the recessed hole to make room for the K-wire Guide.

Aiming for the central body of the calcaneus, insert the 1.6 mm K-wire through the K-wire Guide.

NOTE: The K-wire Guide has the ability to place the K-wire for the 5.5 mm screw 15° off-axis in any direction. Directing the screw greater than 15° off-axis may result in a screw head that is not seated in the plate.

Remove the K-wire Guide from the recessed hole. Confirm K-wire position under fluoroscopy.



Measure K-wire length using the cannulated depth gauge.

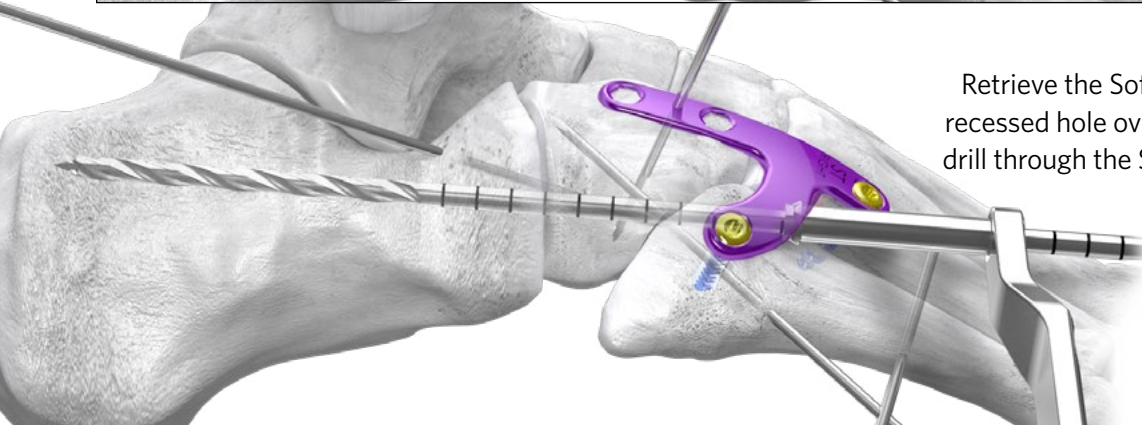

Retrieve the Soft Tissue Protector and mate with the recessed hole over the K-wire. Using the 3.5 mm Drill, drill through the Soft Tissue Protector over the K-wire.

Remove the Soft Tissue Protector and K-wire to allow 5.5 mm screw insertion.

SURGICAL TECHNIQUE GUIDE:

LATERAL COLUMN ARTHRODESIS

CROSSING SCREW PLACEMENT

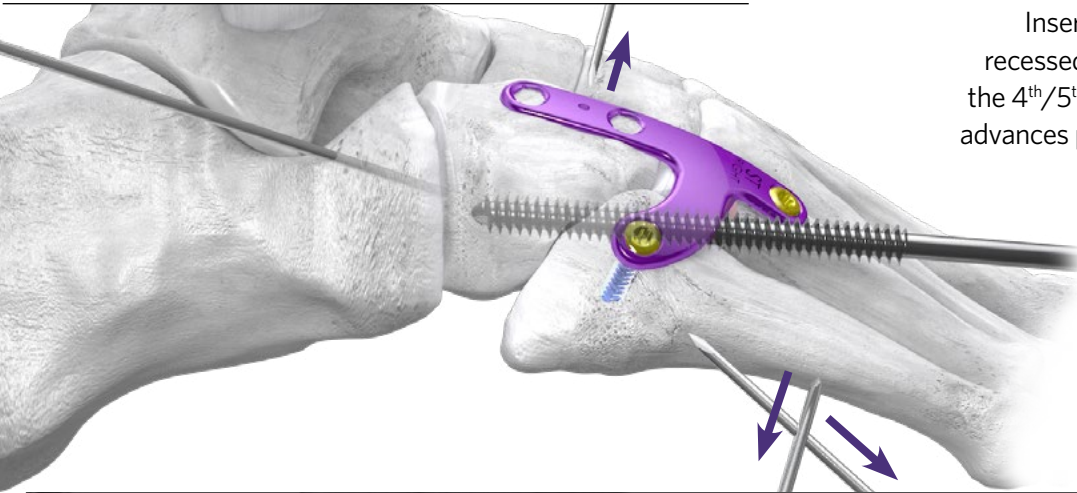

Insert the selected 5.5 mm screw through the recessed hole. Remove temporary fixation across the 4th/5th metatarsal-cuboid joint as the screw tip advances past this joint if using a partially threaded screw to allow for compression. Remove the threaded K-wire in the cuboid from the plate.

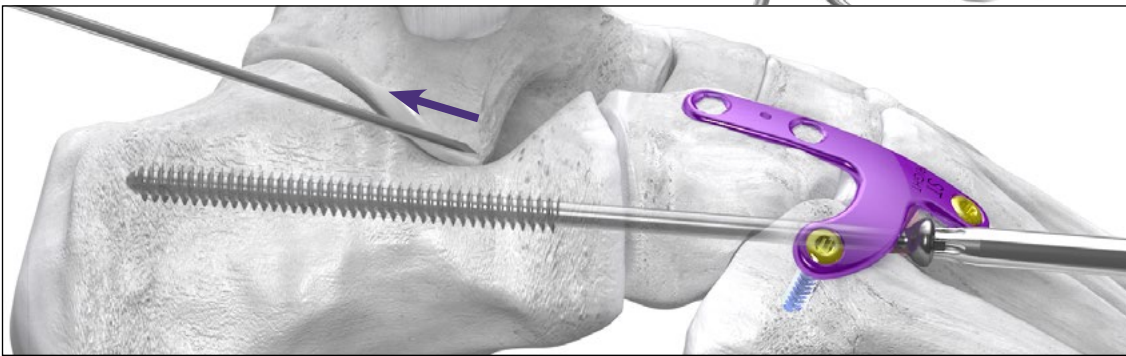

Continue screw insertion. Remove temporary fixation across the calcaneocuboid joint before screw is fully seated in plate hole.



Using the technique described for inserting plate screws, insert the final plate screws into the plate holes in the cuboid.



Confirm screw length and position using fluoroscopy. Additional fixation for the calcaneocuboid joint should be considered at the surgeon's discretion.

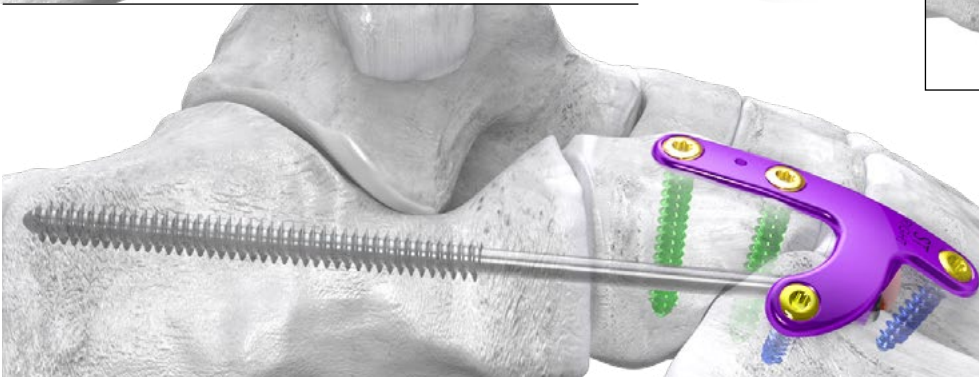

CLOSURE

Proceed to incision closure or concomitant procedures at this time.

Lateral Column Fusion Plating System Caddy

The Gorilla® Lateral Column Fusion Plating System Caddy contains the Standard and Large Lateral Column Fusion Plates and Type II Anodized 5.5 mm Beaming Plate Screws. All instrumentation specific to the Lateral Column Fusion Plating System is located in the caddy including the Plate Templates, Joint Preparation Paddle, Reamer, K-wire Guide, Tissue Protector, Depth Gauge, 3.5 mm Drill, the Ø5.5 mm Gorilla Driver and the 1.6 mm K-wires.



Gorilla® R3CON Instrument Caddy

Drills, drill guides, centering guides, olive wires, plate benders, drivers, K-wires and a depth gauge are located in the Gorilla® R3CON Instrument Caddy.



Additional Gorilla® Caddies





The Gorilla® Case has room for additional Gorilla® Plate Caddies or PRESERVE™ Allograft caddies that may be needed for additional procedures performed in addition to a lateral column arthrodesis.

Gorilla® Case



Gorilla® Screw Optionality

The Gorilla® screw length options for both locking and non-locking screws are as follows:

2.7 mm	1 mm increments, 8-20 mm	
2.7 mm	2 mm increments, 22-40 mm	
3.5 mm	2 mm increments, 10-50 mm	
4.2 mm	2 mm increments, 10-50 mm	
4.2 mm	5 mm increments, 55-70 mm	

Gorilla® R3CON Instruments

The Caspar Compression/Distraction device, osteotomes, baby Bennet retractors, bone reduction clamps, periosteal elevator, cartilage removal device, pin distractor and handles are located at the bottom of the Gorilla® Case.

Refer to www.paragon28.com/ifus for the complete and most current instructions for use document.

INDICATIONS FOR USE: BABY GORILLA®/GORILLA® PLATING SYSTEM

The bone plates and bone screws of the Baby Gorilla®/Gorilla® Plating System are indicated for use in stabilization and fixation of fractures or osteotomies; intra and extra articular fractures, joint depression, and multi-fragmentary fractures; revision procedures, joint fusion and reconstruction of small bones of the toes, feet and ankles including the distal tibia, distal fibula, talus, and calcaneus. The system can be used in both adult and pediatric patients.

In addition, the non-locking, titanium alloy (Ti6Al4V ELI) screws and washers are indicated for use in bone reconstruction, osteotomy, arthrodesis, joint fusion, fracture repair and fracture fixation of the foot and ankle, including the tibia, fibula, tarsus, metatarsals, and phalanges, appropriate for the size of the device.

CONTRAINDICATIONS

Use of the Baby Gorilla®/Gorilla® Plating System is contraindicated in cases of inflammation, cases of active or suspected sepsis / infection and osteomyelitis; or in patients with certain metabolic diseases.

All applications that are not defined by the indications are contraindicated. In addition, surgical success can be adversely affected by:

- Acute or chronic infections, local or systemic
- Vascular, muscular or neurological pathologies that compromise the concerned extremity
- All concomitant pathologies that could affect the function of the implant
- Osteopathies with reduced bone substance that could affect the function of the implant
- Any mental or neuromuscular disorder that could result in an unacceptable risk of failure at the time of fixation or complications in post-operative treatment
- Known or suspected sensitivity to metal
- Corpulence; an overweight or corpulent patient can strain the implant to such a degree that stabilization or implant failure can occur
- Whenever the use of the implant comes into conflict with the anatomical structures of physiological status

Other medical or surgical pre-conditions that could compromise the potentially beneficial procedure, such as:

- The presence of tumors
- Congenital abnormalities
- Immunosuppressive pathologies
- Increased sedimentation rates that cannot be explained by other pathologies
- Increased leukocyte (WBC) count
- Pronounced left shift in the differential leukocyte count

POTENTIAL COMPLICATIONS AND ADVERSE REACTIONS

In any surgical procedure, the potential for complications and adverse reactions exist. The risks and complications with these implants include:

- Loosening, deformation or fracture of the implant
- Acute post-operative wound infections and late infections with possible sepsis
- Migration, subluxation of the implant with resulting reduction in range of movement
- Fractures resulting from unilateral joint loading
- Thrombosis and embolism
- Wound hematoma and delayed wound healing
- Temporary and protracted functional neurological perturbation
- Tissue reactions as the result of allergy or foreign body reaction to dislodged particles
- Corrosion with localized tissue reaction and pain
- Pain, a feeling of malaise or abnormal sensations due to the implant used
- Bone loss due to stress shielding

All possible complications listed here are not typical of Paragon 28®, Inc. products but are in principle observed with any implant. Promptly inform Paragon 28®, Inc. as soon as complications occur in connection with the implants or surgical instruments used. In the event of premature failure of an implant in which a causal relationship with its geometry, surface quality or mechanical stability is suspected, please provide Paragon 28®, Inc. with the explant(s) in a cleaned, disinfected and sterile condition. Paragon 28®, Inc. cannot accept any other returns of used implants. The surgeon is held liable for complications associated with inadequate asepsis, inadequate preparation of the osseous implant bed in the case of implants, incorrect indication or surgical technique or incorrect patient information and consequent incorrect patient behavior.

WARNINGS AND PRECAUTIONS

- Re-operation to remove or replace implants may be required at any time due to medical reasons or device failure. If corrective action is not taken, complications may occur.
- Use of an undersized plate or screw in areas of high functional stresses may lead to implant fracture and failure.
- Plates and screws, wires, or other appliances of dissimilar metals should not be used together in or near the implant site.
- The implants and guide wires are intended for single use only.
- Instruments, guide wires and screws are to be treated as sharps.
- Patient risk as a result of the Baby Gorilla®/Gorilla® Plating System in the MR environment has been minimized.
- **Do not use other manufacturer's instruments or implants in conjunction with the Baby Gorilla®/Gorilla® Plating System.**
- **Do not implant the instruments.**

Refer to www.paragon28.com/ifus for the complete and most current instructions for use document.

MRI SAFETY INFORMATION



A person with the Paragon 28® Baby Gorilla®/Gorilla® Plating System may be safely scanned under the following conditions. Failure to follow these conditions may result in injury.

Name/Identification of Device	Paragon 28® Baby Gorilla®/Gorilla® Plating System
Nominal value(s) of Static Magnetic Field [T]	1.5 T or 3 T
Maximum Spatial Field Gradient [T/m and gauss/cm]	30 T/m (3000 gauss/cm)
RF Excitation	Circularly Polarized (CP)
RF Transmit Coil Type	Whole body transmit coil, Head RF transmit-receive coil
Operating Mode	Normal Operating Mode
Maximum Whole Body SAW [W/kg]	2.0 W/kg (Normal Operating Mode)
Limits on Scan Duration	2.0 W/kg whole body average SAR for 60 minutes of continuous RF (a sequence or back to back series/scan without breaks)
MR Image Artifact	The presence of this implant may produce an image artifact.



Gorilla[®] Lateral Column Fusion Plating System

PATENTED, DESIGNED & EXCLUSIVELY DISTRIBUTED BY

Exclusively foot & ankle
Paragon²⁸[®]

P51-STG-3010 Rev B [2024-05-15]

™Trademarks and ®Registered Marks of Paragon 28®, Inc.

© Copyright 2024 Paragon 28®, Inc. All rights reserved.

Patents: www.paragon28.com/patents

Paragon 28, Inc. 🏢
14445 Grasslands Dr.
Englewood, CO 80112
(855) 786-2828

Australian Sponsor
Actis Medical Pty Ltd.
Ground Floor, U1/18 Dequetteville Terrace
Kent Town, SA 5067
Australia

DISCLAIMER

The purpose of the Lateral Column Arthrodesis Surgical Technique Guide is to demonstrate the use of the Lateral Column Fusion Plating System Plates in the Gorilla® R3CON Plating System. Although various methods can be employed for this procedure, the fixation options demonstrated were chosen for simplicity of explanation and demonstration of the unique features of our device. Federal law (U.S.A.) restricts this device to sale and use by, or on order of, a physician.

www.Paragon28.com